

LV UltraMOV® Series

Radial Leaded Varistors

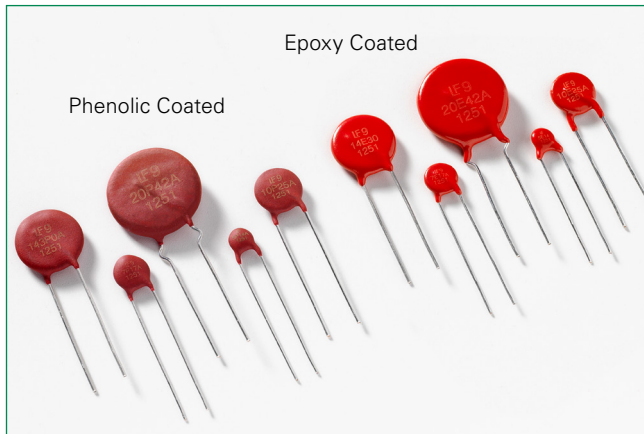

Description

The Littelfuse LV UltraMOV® Varistor Series provides an ideal circuit protection solution for DC voltage applications.

The maximum peak surge current rating can reach up to 10kA (8/20µs pulse) to protect against the damage from high peak surge current induced by indirect lightning strike interference, system switching transients, and abnormal fast transients from the power source.

Available in five model sizes: 5mm, 7mm, 10mm, 14mm, and 20mm, these device feature a wide voltage range from 14V to 125V.

Features & Benefits

- Breakthrough in low voltage varistor design provides high peak (up to 10KA) surge current rating
- High operating temperature range up to 125°C (phenolic coating option)
- Reduced footprint and volume required for surge protection
- 5 model sizes available: 5, 7, 10, 14, and 20mm
- Wide operating voltage range VM(AC)RMS 11V to 95V and V M(DC) 14V to 125V
- 10mm, 14mm and 20mm devices are UL Recognized and TUV certified with 800V isolation voltage rating.
- Lead-free, Halogen-Free and RoHS compliant

Additional Information



Resources



Accessories



Samples

Agency Approvals

Agency	Agency Approval	Agency File Number
cULus	UL 1449	E320116 ¹
UL	UL 1449	E320116 ²
A	IEC/EN61051 IEC 61051-2 IEC 61051-2-2 IEC 60950-1 (Annex Q)	J 50324242 ³

Notes:

- 10mm, 14mm and 20mm phenolic coated parts are UL Recognized for the US and Canada.
- All epoxy coated parts (in all sizes) are UL Recognized for the US.
- 10mm, 14mm and 20mm phenolic coated parts only.

Applications

- LED lights
- Automation control systems
- Cordless phones
- Industrial control contact relays
- Audio and video devices
- Surge protection device
- Mobile phone chargers
- Telecom power systems
- Security systems
- Wireless base stations
- Fire alarm systems

Absolute Maximum Ratings

For ratings of individual members of a series, see Device Ratings and Specifications chart

	Low Voltage Series	Units
Continuous:		
Steady State Applied Voltage:		
AC Voltage Range ($V_{M(AC)RMS}$)	11 to 95	V
DC Voltage Range ($V_{M(DC)}$)	14 to 125	V
Transient:		
Non-Repetitive Surge Current, 8/20µs Waveform (I_{TM})	500 to 10,000	A
Non-Repetitive Energy Capability, 2ms Waveform (W_{TM})	0.8 to 150	J
Operating Ambient Temperature Range (T_A) for Epoxy coated	-40 to +85	°C
Operating Ambient Temperature Range (T_A) for Phenolic coated	-40 to +125	°C
Storage Temperature Range (T_{STG}) for Epoxy coated	-40 to +125	°C
Storage Temperature Range (T_{STG}) for Phenolic coated	-40 to +150	°C
Temperature Coefficient (αV) of Clamping Voltage (V_C) at Specified Test Current	< 0.01 %	°C
Hi-Pot Encapsulation (Isolation Voltage Capability) for Epoxy coated	2500	V
Hi-Pot Encapsulation (Isolation Voltage Capability) for Phenolic coated	800	V
Epoxy Coating Insulation Resistance	>1,000	MΩ

CAUTION: Stresses above those listed in "Absolute Maximum Ratings" may cause permanent damage to the device. This is a stress only rating and operation of the device at these or any other conditions above those indicated in the operational sections of this specification is not implied.

LV UltraMOV® Series

Radial Leded Varistors

LV UltraMOV® Series Device Ratings and Specifications

Epoxy Coated Models		Phenolic Coated Models ²		Size Disc Dia. (mm)	Max Continuous Voltage		Varistor Voltage at 1mA			Maximum Clamping Voltage		Max Peak Current (8 x 20µs 1 pulse)	Energy Rating (2ms, 1pulse)	Typical Capacitance f = 1MHz
Part Number (Base part)	Branding	Part Number (Base part)	Branding		V _{M(AC)RMS}	V _{M(DC)}	V _{NOM Min}	V _{NOM Nom}	V _{NOM Max}	V _C	I _{PK}	I _{TM}	W _{TM}	C
					(V)	(V)	(V)	(V)	(V)	(V)	(A)	(A)	(J)	(pF)
V05E11P	P5E11	V05P11P	P5P11	5	11	14	16.2	18.0	19.8	36	1	500	0.8	1300
V07E11P	P7E11	V07P11P	P7P11	7	11	14	16.2	18.0	19.8	36	2.5	1000	2.0	2900
V10E11P	P10E11	V10P11P	P10P11	10	11	14	16.2	18.0	19.8	36	5	2000	4.2	5450
V14E11P	P14E11	V14P11P	P14P11	14	11	14	16.2	18.0	19.8	36	10	4000	8	12000
V20E11P	P20E11	V20P11P	P20P11	20	11	14	16.2	18.0	19.8	36	20	8000	25	26000
V05E14P	P5E14	V05P14P	P5P14	5	14	18	19.8	22.0	24.2	43	1	500	1	1100
V07E14P	P7E14	V07P14P	P7P14	7	14	18	19.8	22.0	24.2	43	2.5	1000	2.2	2450
V10E14P	P10E14	V10P14P	P10P14	10	14	18	19.8	22.0	24.2	43	5	2000	5	4650
V14E14P	P14E14	V14P14P	P14P14	14	14	18	19.8	22.0	24.2	43	10	4000	10	10200
V20E14P	P20E14	V20P14P	P20P14	20	14	18	19.8	22.0	24.2	43	20	8000	28	22200
V05E17P	P5E17	V05P17P	P5P17	5	17	22	24.3	27.0	29.7	53	1	500	1.4	950
V07E17P	P7E17	V07P17P	P7P17	7	17	22	24.3	27.0	29.7	53	2.5	1000	2.8	2100
V10E17P	P10E17	V10P17P	P10P17	10	17	22	24.3	27.0	29.7	53	5	2000	6.5	3900
V14E17P	P14E17	V14P17P	P14P17	14	17	22	24.3	27.0	29.7	53	10	4000	13	8700
V20E17P	P20E17	V20P17P	P20P17	20	17	22	24.3	27.0	29.7	53	20	8000	35	18750
V05E20P	P5E20	V05P20P	P5P20	5	20	26	29.7	33.0	36.3	65	1	500	2	850
V07E20P	P7E20	V07P20P	P7P20	7	20	26	29.7	33.0	36.3	65	2.5	1000	4.2	1750
V10E20P	P10E20	V10P20P	P10P20	10	20	26	29.7	33.0	36.3	65	5	2000	10	3400
V14E20P	P14E20	V14P20P	P14P20	14	20	26	29.7	33.0	36.3	65	10	4000	20	7500
V20E20P	P20E20	V20P20P	P20P20	20	20	26	29.7	33.0	36.3	65	20	8000	58	15000
V05E23P	P5E23	V05P23P	P5P23	5	23	28	32.4	36.0	39.6	71	1	500	2.2	800
V07E23P	P7E23	V07P23P	P7P23	7	23	28	32.4	36.0	39.6	71	2.5	1000	5.0	1650
V10E23P	P10E23	V10P23P	P10P23	10	23	28	32.4	36.0	39.6	71	5	2000	12	3200
V14E23P	P14E23	V14P23P	P14P23	14	23	28	32.4	36.0	39.6	71	10	4000	23	7000
V20E23P	P20E23	V20P23P	P20P23	20	23	28	32.4	36.0	39.6	71	20	8000	70	14000
V05E25P	P5E25	V05P25P	P5P25	5	25	31	35.1	39.0	42.9	77	1	500	2.5	750
V07E25P	P7E25	V07P25P	P7P25	7	25	31	35.1	39.0	42.9	77	2.5	1000	5.5	1500
V10E25P	P10E25	V10P25P	P10P25	10	25	31	35.1	39.0	42.9	77	5	2000	13	2900
V14E25P	P14E25	V14P25P	P14P25	14	25	31	35.1	39.0	42.9	77	10	4000	25	6200
V20E25P	P20E25	V20P25P	P20P25	20	25	31	35.1	39.0	42.9	77	20	8000	77	13500
V05E30P	P5E30	V05P30P	P5P30	5	30	38	42.3	47.0	51.7	93	1	500	3.1	650
V07E30P	P7E30	V07P30P	P7P30	7	30	38	42.3	47.0	51.7	93	2.5	1000	7	1350
V10E30P	P10E30	V10P30P	P10P30	10	30	38	42.3	47.0	51.7	93	5	2000	15.5	2550
V14E30P	P14E30	V14P30P	P14P30	14	30	38	42.3	47.0	51.7	93	10	4000	32	5550
V20E30P	P20E30	V20P30P	P20P30	20	30	38	42.3	47.0	51.7	93	20	8000	90	12000
V05E35P	P5E35	V05P35P	P5P35	5	35	45	50.4	56.0	61.6	93	1	500	4	550
V07E35P	P7E35	V07P35P	P7P35	7	35	45	50.4	56.0	61.6	110	2.5	1000	9	1200
V10E35P	P10E35	V10P35P	P10P35	10	35	45	50.4	56.0	61.6	110	5	2000	20	2200
V14E35P	P14E35	V14P35P	P14P35	14	35	45	50.4	56.0	61.6	110	10	4000	40	5000
V20E35P	P20E35	V20P35P	P20P35	20	35	45	50.4	56.0	61.6	110	20	8000	115	10500
V05E40P	P5E40	V05P40P	P5P40	5	40	56	61.2	68.0	74.8	135	1	500	5	500
V07E40P	P7E40	V07P40P	P7P40	7	40	56	61.2	68.0	74.8	135	2.5	1000	11	1000
V10E40P	P10E40	V10P40P	P10P40	10	40	56	61.2	68.0	74.8	135	5	2000	25	1850
V14E40P	P14E40	V14P40P	P14P40	14	40	56	61.2	68.0	74.8	135	10	4000	50	4000
V20E40P	P20E40	V20P40P	P20P40	20	40	56	61.2	68.0	74.8	135	20	8000	140	8500

Notes:

1. Average power dissipation of transients not to exceed 0.2W, 0.25W, 0.4W, 0.6W or 1W for model sizes 5mm, 7mm, 10mm, 14mm, and 20mm, respectively.
2. 10mm, 14mm and 20mm devices are UL recognized with 800V isolation voltage rating.

LV UltraMOV® Series

Radial Leaded Varistors

Epoxy Coated Models		Phenolic Coated Models ²		Size Disc Dia. (mm)	Max Continuous Voltage		Varistor Voltage at 1mA			Maximum Clamping Voltage		Max Peak Current (8 x 20µs 1 pulse)	Energy Rating (2ms, 1pulse)	Typical Capacitance f = 1MHz
Part Number (Base part)	Branding	Part Number (Base part)	Branding		V _{M(AC)RMS}	V _{M(DC)}	V _{NOM Min}	V _{NOM Nom}	V _{NOM Max}	V _C	I _{PK}	I _{TM}	W _{TM}	C
					(V)	(V)	(V)	(V)	(V)	(V)	(A)	(A)	(J)	(pF)
V05E50P	P5E50	V05P50P	P5P50	5	50	65	73.8	82	90.2	135	5	800	5	350
V07E50P	P7E50	V07P50P	P7P50	7	50	65	73.8	82	90.2	135	10	1750	10	800
V10E50P	P10E50	V10P50P	P10P50	10	50	65	73.8	82	90.2	135	25	3500	20	1400
V14E50P	P14E50	V14P50P	P14P50	14	50	65	73.8	82	90.2	145	50	6500	40	3000
V20E50P	P20E50	V20P50P	P20P50	20	50	65	73.8	82	90.2	145	100	10000	80	6000
V05E60P	P5E60	V05P60P	P5P60	5	60	85	90	100	110	165	5	800	6	310
V07E60P	P7E60	V07P60P	P7P60	7	60	85	90	100	110	165	10	1750	12	700
V10E60P	P10E60	V10P60P	P10P60	10	60	85	90	100	110	165	25	3500	24	1200
V14E60P	P14E60	V14P60P	P14P60	14	60	85	90	100	110	175	50	6500	50	2500
V20E60P	P20E60	V20P60P	P20P60	20	60	85	90	100	110	175	100	10000	100	5200
V05E75P	P5E75	V05P75P	P5P75	5	75	100	108	120	132	205	5	800	7	260
V07E75P	P7E75	V07P75P	P7P75	7	75	100	108	120	132	205	10	1750	14	600
V10E75P	P10E75	V10P75P	P10P75	10	75	100	108	120	132	200	25	3500	29	1100
V14E75P	P14E75	V14P75P	P14P75	14	75	100	108	120	132	210	50	6500	60	2300
V20E75P	P20E75	V20P75P	P20P75	20	75	100	108	120	132	210	100	10000	120	4800
V05E95P	P5E95	V05P95P	P5P95	5	95	125	135	150	165	250	5	800	9	200
V07E95P	P7E95	V07P95P	P7P95	7	95	125	135	150	165	250	10	1750	18	520
V10E95P	P10E95	V10P95P	P10P95	10	95	125	135	150	165	250	25	3500	36	800
V14E95P	P14E95	V14P95P	P14P95	14	95	125	135	150	165	250	50	6500	75	1700
V20E95P	P20E95	V20P95P	P20P95	20	95	125	135	150	165	250	100	10000	150	3700

Notes:

1. Average power dissipation of transients not to exceed 0.2W, 0.25W, 0.4W, 0.6W or 1W for model sizes 5mm, 7mm, 10mm, 14mm, and 20mm respectively.
2. 10mm, 14mm and 20mm devices are UL recognized and TUV certified with 800V isolation voltage rating.

LV UltraMOV® Series

Radial Leaded Varistors

Current Energy and Power Dissipation Ratings

Figure 1A - Power Derating for Epoxy Coated

For applications exceeding 85°C ambient temperature, the peak surge current and energy ratings must be reduced as shown below.

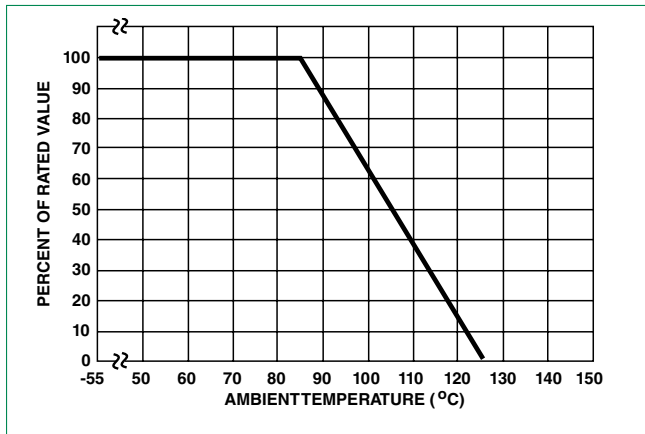
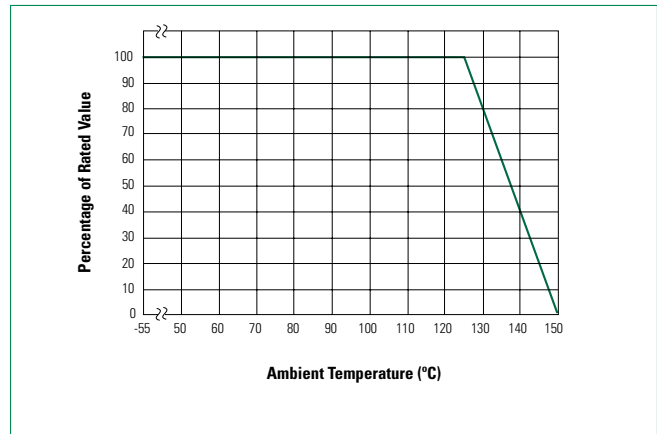

Figure 1B - Power Derating for Phenolic Coated

For applications exceeding 125°C ambient temperature, the peak surge current and energy ratings must be reduced as shown below.



Peak Pulse Current Test Waveform for Clamping Voltage

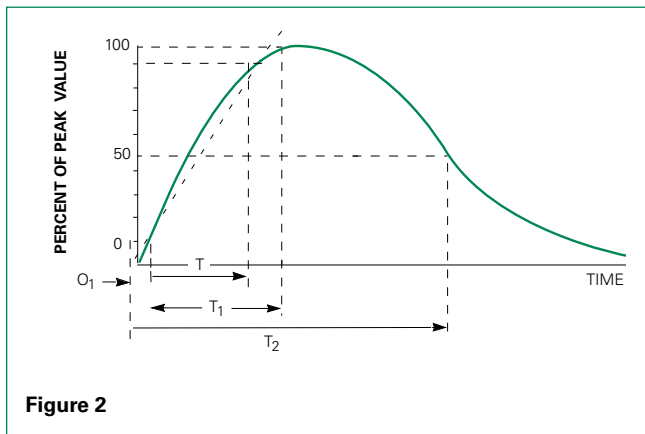

Figure 2

- O_1 = Virtual Origin of Wave
- T = Time from 10% to 90% of Peak
- T_1 = Rise Time = $1.25 \times T$
- T_2 = Decay Time

Example - For an 8/20 μ s Current Waveform:

- 8μ s = T_1 = Rise Time
- 20μ s = T_2 = Decay Time

LV UltraMOV® Series

Radial Leded Varistors

Maximum Clamping Voltage for 5mm Parts
V05x11P - V05x40P

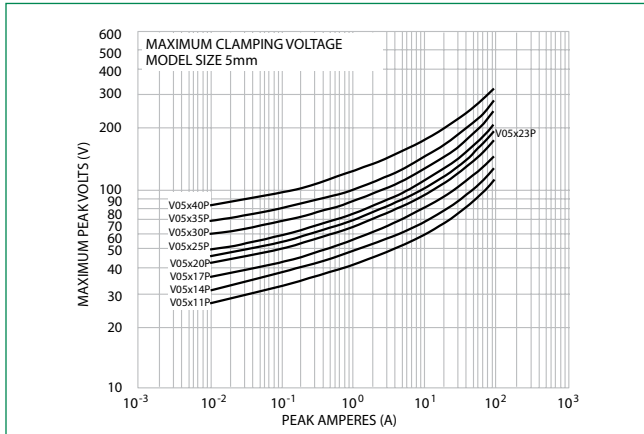

Maximum Clamping Voltage for 7mm Parts
V07x11P - V07x40P

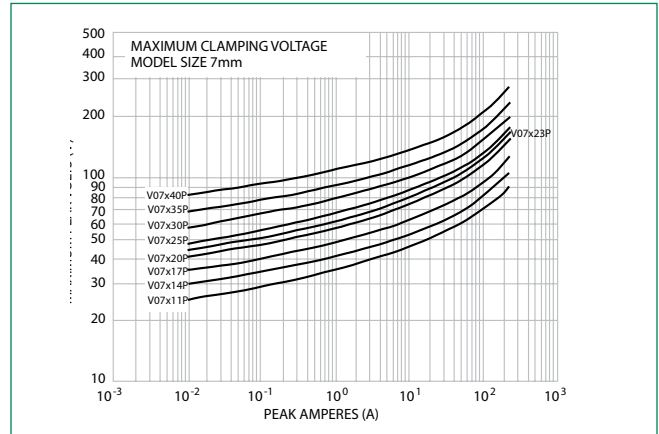

Maximum Clamping Voltage for 10mm Parts
V10x11P - V10x40P

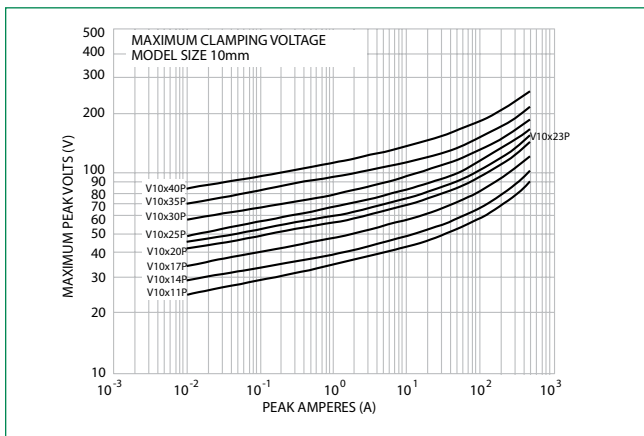

Maximum Clamping Voltage for 14mm Parts
V14x11P - V14x40P

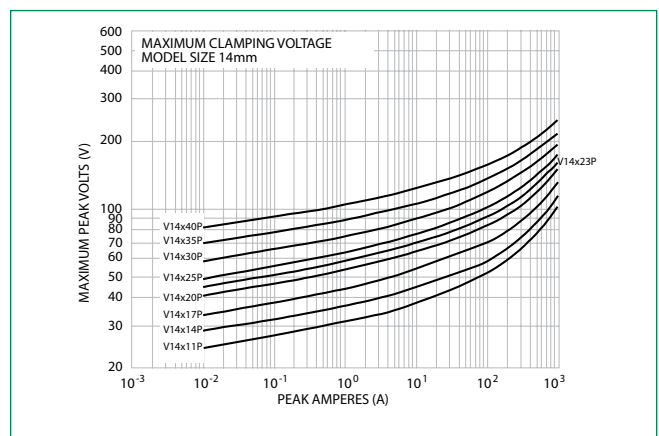

Maximum Clamping Voltage for 20mm Parts
V20x11P - V20x40P

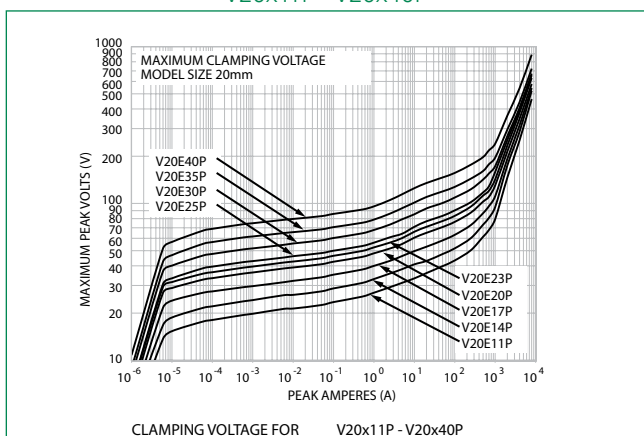

CLAMPING VOLTAGE FOR V20x11P - V20x40P

LV UltraMOV® Series

Radial Leded Varistors

Maximum Clamping Voltage for 5mm Parts

V05x50P - V05x95P

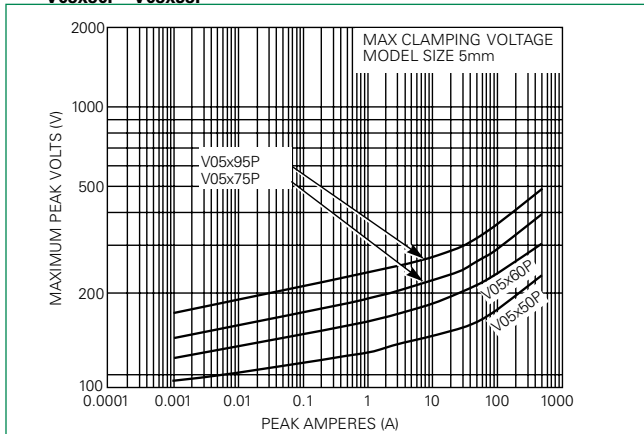

Maximum Clamping Voltage for 7mm Parts

V07x50P - V07x95P

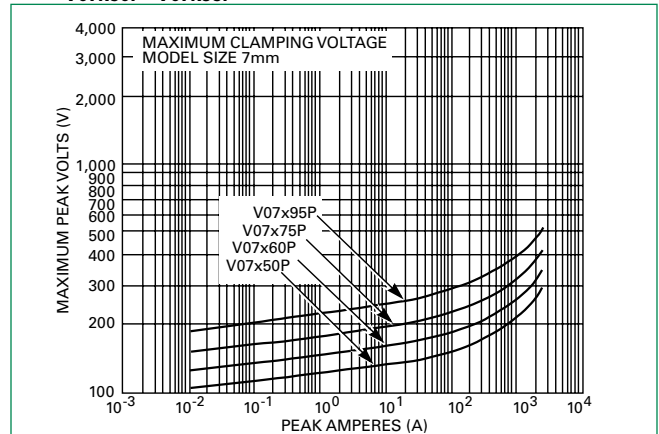

Maximum Clamping Voltage for 10mm Parts

V10x50P - V10x95P

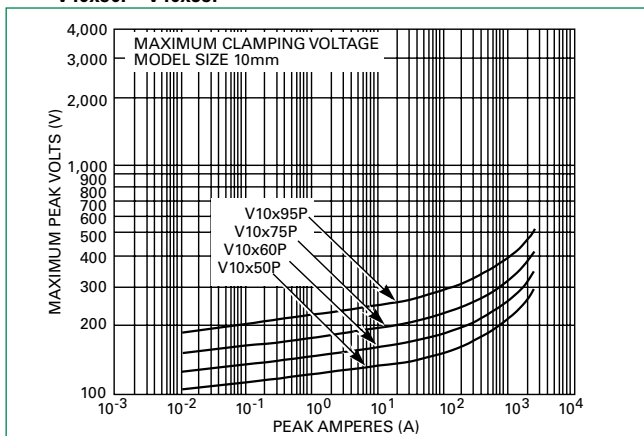

Maximum Clamping Voltage for 14mm Parts

V14x50P - V14x95P

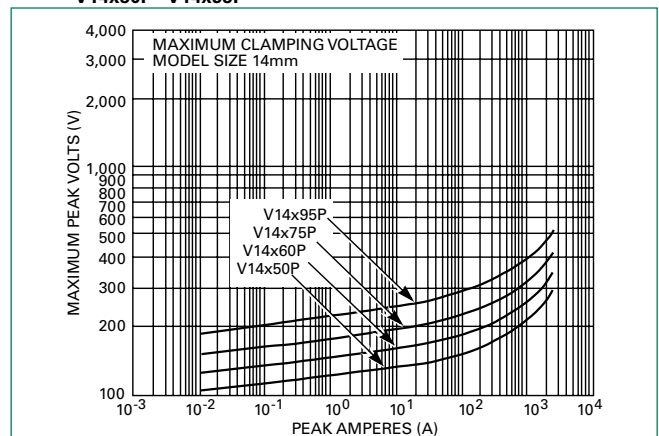

Maximum Clamping Voltage for 20mm Parts

V20x50P - V20x95P

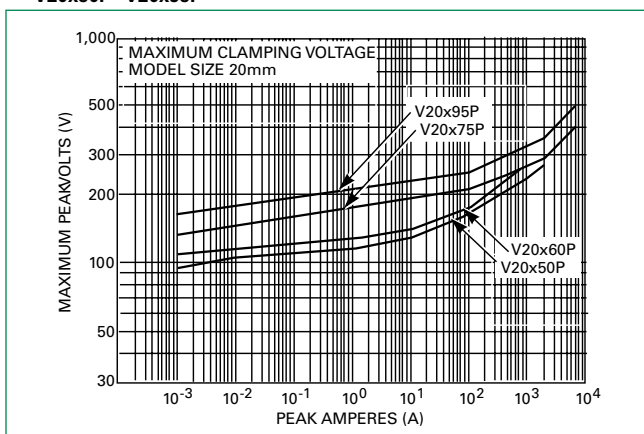

LV UltraMOV® Series

Radial Leded Varistors

Repetitive Surge Capability for 5mm Parts

V05x11P - V05x40P

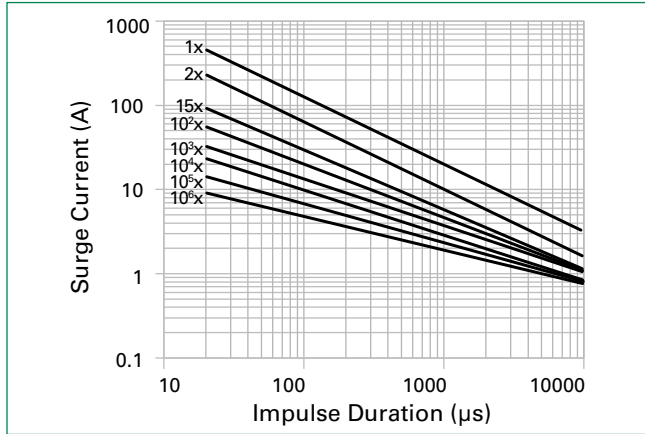

Repetitive Surge Capability for 7mm Parts

V07x11P - V07x40P

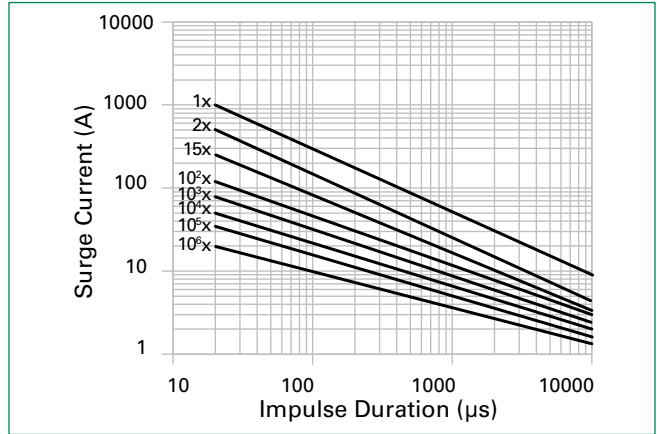

Repetitive Surge Capability for 10mm Parts

V10x11P - V10x40P

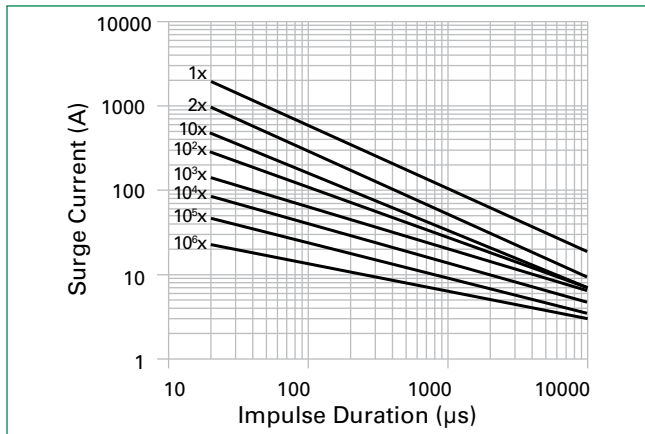

Repetitive Surge Capability for 14mm Parts

V14x11P - V14x40P

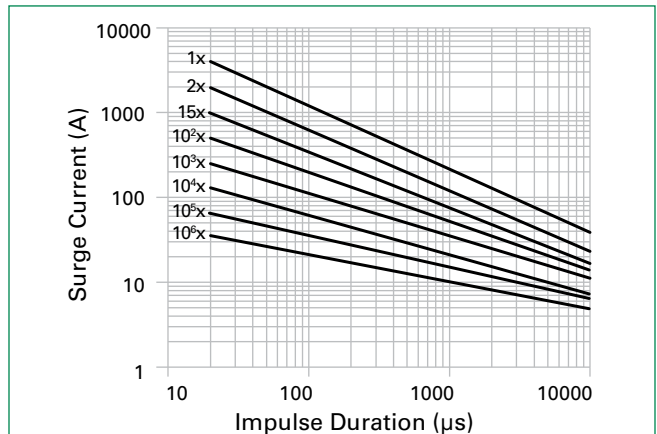

Repetitive Surge Capability for 20mm Parts

V20x11P - V20x40P

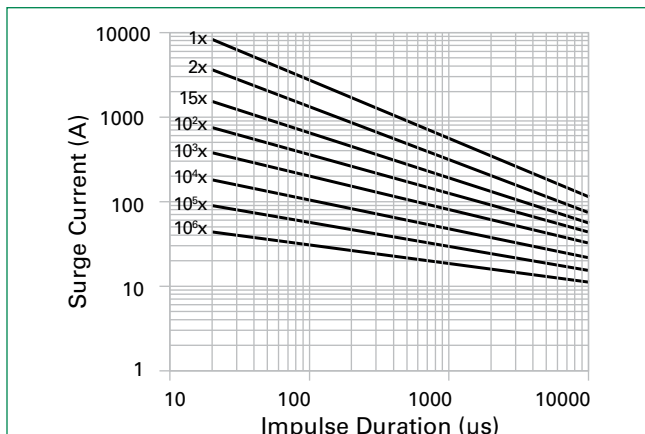

Note: If pulse ratings are exceeded, a shift of V_{NDCI} (at specified current) of more than +/-10% could result. This type of shift, which normally results in a decrease of V_{NDCI} , may result in the device not meeting the original published specifications, but does not prevent the device from continuing to function, and to provide ample protection.

LV UltraMOV® Series

Radial Leded Varistors

Repetitive Surge Capability for 5mm Parts

V05x50P - V05x95P

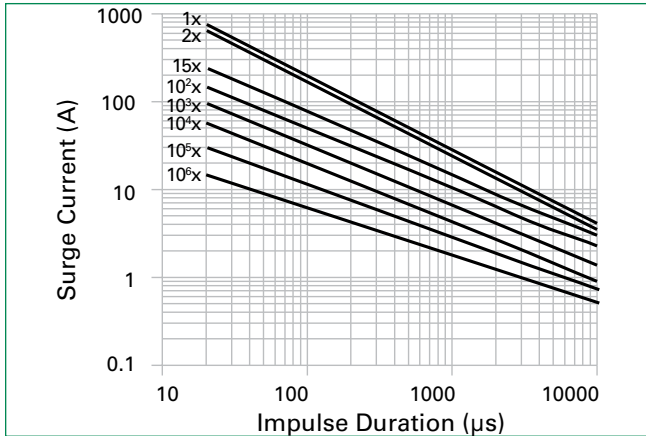

Repetitive Surge Capability for 7mm Parts

V07x50P - V07x95P

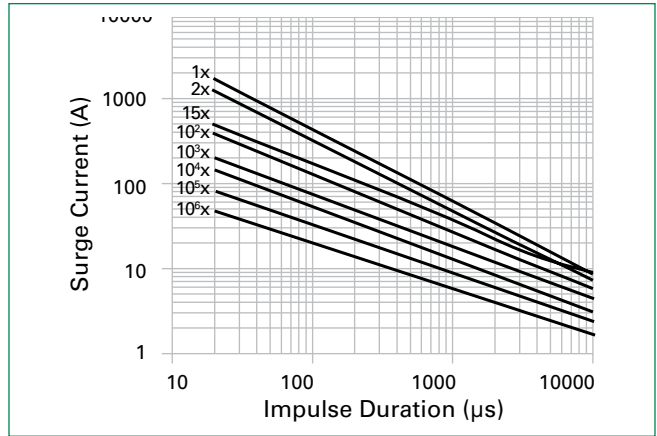

Repetitive Surge Capability for 10mm Parts

V10x50P - V10x95P

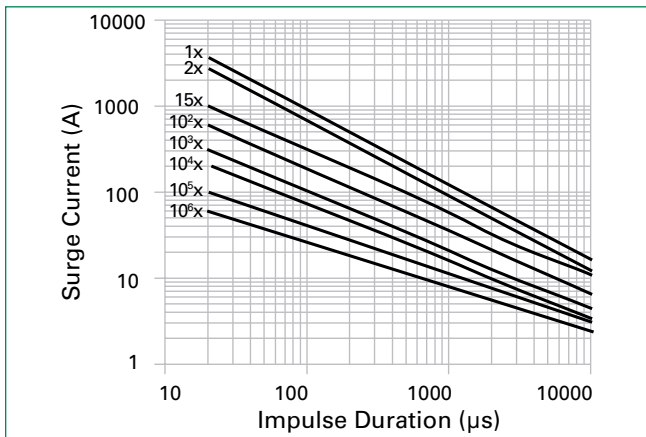

Repetitive Surge Capability for 14mm Parts

V14x50P - V14x95P

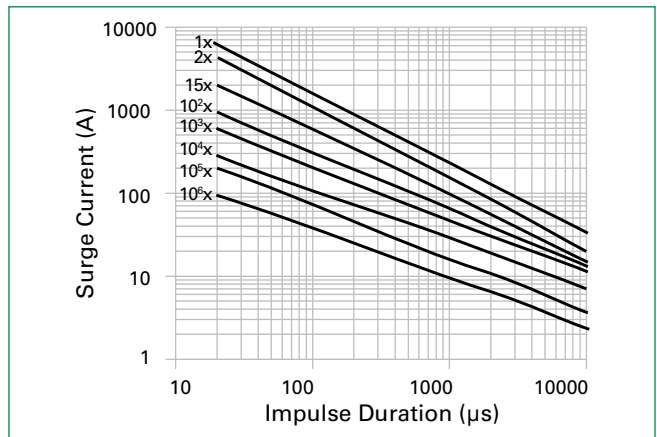

Repetitive Surge Capability for 20mm Parts

V20x50P - V20x95P

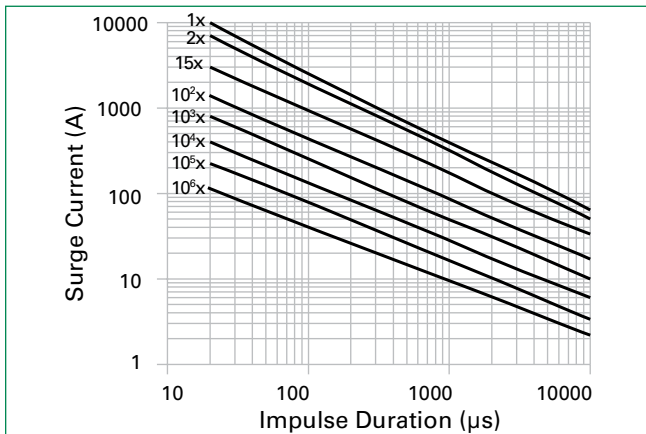

LV UltraMOV® Series

Radial Ledged Varistors

Wave Solder Profile

Non Lead-free Profile

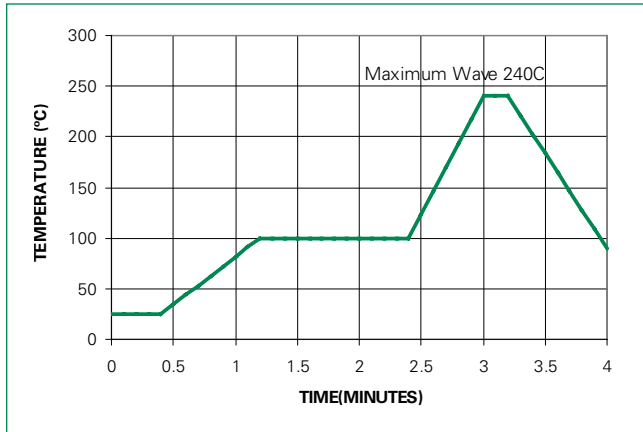

Lead-free Profile



Physical Specifications

Lead Material	Copper Clad Steel Wire
Soldering Characteristics	Solderability per MIL-STD-202, Method 208
Insulating Material	Cured, flame retardant epoxy polymer meets UL94V-0 requirements
Device Labeling	Marked with LF, voltage and date code

Environmental Specifications

Humidity Aging	+85°C, 85% RH, 1000 hours +/-10% typical voltage change
Thermal Shock	+85°C to -40°C 10 times +/-10% typical voltage change
Solvent Resistance	MIL-STD-202, Method 215
Moisture Sensitivity	Level 1, J-STD-020

LV UltraMOV® Series

Radial Leded Varistors

Product Dimensions (mm)

Straight Lead

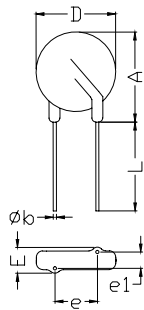

Outer Crimp Lead

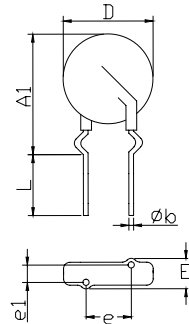

In-Line (Under Crimp) Lead

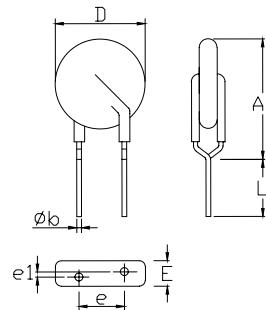

Inner Crimp Lead

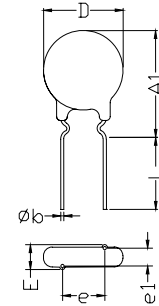

Dimension	V _{RMS} Voltage Model	5mm Size		7mm Size		10mm Size		14mm Size		20mm Size	
		Min. mm (in)	Max. mm (in)	Min. mm (in)	Max. mm (in)	Min. mm (in)	Max. mm (in)	Min. mm (in)	Max. mm (in)	Min. mm (in)	Max. mm (in)
A	All	-	10 (0.394)	-	12 (0.472)	-	16 (0.630)	-	20 (0.787)	-	26.5 (1.043)
A1	All	-	13 (0.512)	-	15 (0.591)	-	19.5 (0.768)	-	22.5 (0.886)	-	29 (1.142)
ØD	All	-	7 (0.276)	-	9 (0.354)	-	12.5 (0.492)	-	17 (0.669)	-	23 (0.906)
e	All	4 (0.157)	6 (0.236)	4 (0.157)	6 (0.236)	6.5 (0.256)	8.5 (0.335)	6.5 (0.256)	8.5 (0.335)	6.5 (0.256)	8.5 (0.335)
e₁	11 - 30	1 (0.039)	3 (0.118)	1 (0.039)	3 (0.118)	1 (0.039)	3 (0.118)	1 (0.039)	3 (0.118)	1 (0.039)	3 (0.118)
	35 - 95	1.5 (0.059)	3.5 (0.138)	1.5 (0.059)	3.5 (0.138)	1.5 (0.059)	3.5 (0.138)	1.5 (0.059)	3.5 (0.138)	1.5 (0.059)	3.5 (0.138)
E	11 - 30	-	5.0 (0.197)	-	5.0 (0.197)	-	5.0 (0.197)	-	5.0 (0.197)	-	5.0 (0.197)
	35 - 95	-	5.6 (0.220)	-	5.6 (0.220)	-	5.6 (0.220)	-	5.6 (0.220)	-	5.6 (0.220)
øb	All	0.585 (0.023)	0.685 (0.027)	0.585 (0.023)	0.685 (0.027)	0.76 (0.030)	0.86 (0.034)	0.76 (0.030)	0.86 (0.034)	0.76 (0.030)	0.86 (0.034)
L	All	25.4 (1.00)	-	25.4 (1.00)	-	25.4 (1.00)	-	25.4 (1.00)	-	25.4 (1.00)	-
L_{TRIM}	All	2.41 (0.095)	4.69 (0.185)	2.41 (0.095)	4.69 (0.185)	2.41 (0.095)	4.69 (0.185)	2.41 (0.095)	4.69 (0.185)	2.41 (0.095)	4.69 (0.185)

LV UltraMOV® Series

Radial Ledged Varistors

Tape and Reel Specifications

5 and 7mm Devices

10, 14, and 20mm Devices

STRAIGHT LEADS "L1"

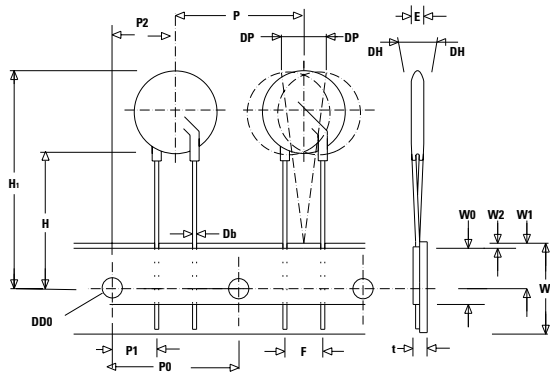

STRAIGHT LEADS "L1"

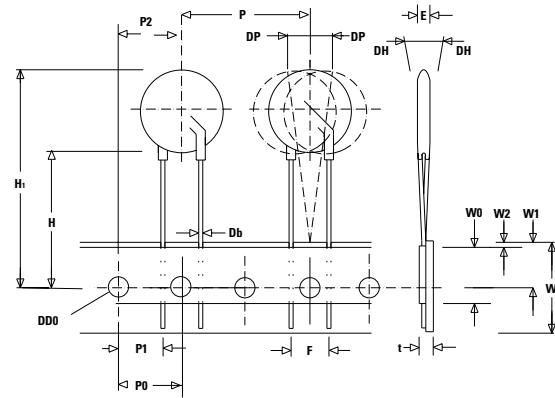

CRIMPED LEADS "L2"

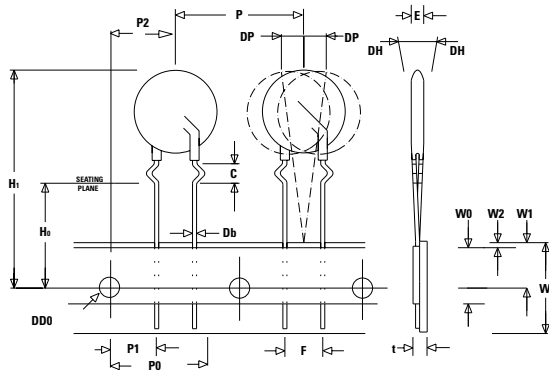

CRIMPED LEADS "L2"

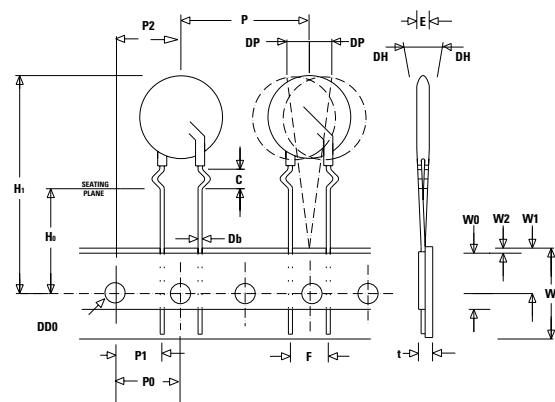

UNDER CRIMPED / IN-LINE LEADS "L3"

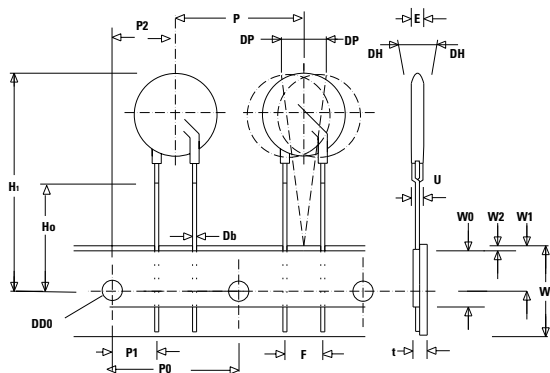

UNDER CRIMPED / IN-LINE LEADS "L3"

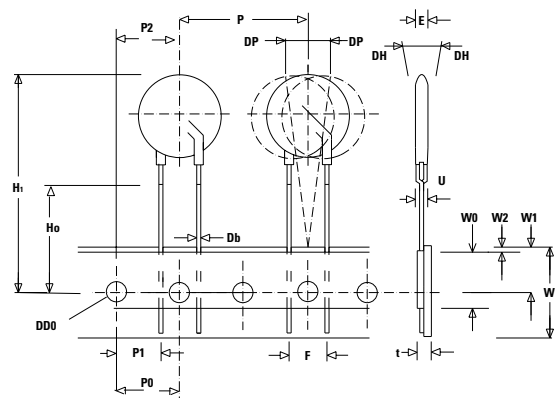

Refer to next page for dimension measurement specifics.

LV UltraMOV® Series

Radial Leaded Varistors

Tape and Reel Specifications (continued)

- Notes:**
- Radial devices on tape are supplied with crimped leads, straight leads, or under-crimped leads
 - Leads are offset by product dimension e1
 - Conforms to ANSI and EIA specifications
 - Can be supplied to IEC Publication 286-2

Symbol	Description	Model Size				
		5mm	7mm	10mm	14mm	20mm
P	Pitch of Component	12.7 +/- 1.0	12.7 +/- 1.0	25.4 +/- 1.0	25.4 +/- 1.0	25.4 +/- 1.0
P ₀	Feed Hole Pitch	12.7 +/- 0.2	12.7 +/- 0.2	12.7 +/- 0.2	12.7 +/- 0.2	12.7 +/- 0.2
P ₁	Feed Hole Center to Pitch	3.85 +/- 0.7	3.85 +/- 0.7	8.85 +/- 0.7	8.85 +/- 0.7	8.85 +/- 0.7
P ₂	Hole Center to Component Center	6.35 +/- 1.0	6.35 +/- 1.0	12.7 +/- 0.7	12.7 +/- 0.7	12.7 +/- 0.7
F	Lead to Lead Distance	5.0 +/- 1.0	5.0 +/- 1.0	7.5 +/- 1.0	7.5 +/- 1.0	7.5 +/- 1.0
h	Component Alignment	2.0 Max	2.0 Max	2.0 Max	2.0 Max	2.0 Max
W	Tape Width	18.0 +1.0 / -0.5	18.0 +1.0 / -0.5	18.0 +1.0 / -0.5	18.0 +1.0 / -0.5	18.0 +1.0 / -0.5
W ₀	Hold Down Tape Width	12.0 +/- 0.3	12.0 +/- 0.3	12.0 +/- 0.3	12.0 +/- 0.3	12.0 +/- 0.3
W ₁	Hole Position	9.0 +0.75 / -0.50	9.0 +0.75 / -0.50	9.0 +0.75 / -0.50	9.0 +0.75 / -0.50	9.0 +0.75 / -0.50
W ₂	Hold Down Tape Position	0.5 Max	0.5 Max	0.5 Max	0.5 Max	0.5 Max
H	Height from Tape Center to Component Base	18.0 +2.0 / -0.0	18.0 +2.0 / -0.0	18.0 +2.0 / -0.0	18.0 +2.0 / -0.0	18.0 +2.0 / -0.0
H ₀	Seating Plane Height	16.0 +/- 0.5	16.0 +/- 0.5	16.0 +/- 0.5	16.0 +/- 0.5	16.0 +/- 0.5
H ₁	Component Height	29.0 Max	32.0 Max	36.0 Max	40.0 Max	46.5 Max
D ₀	Feed Hole Diameter	4.0 +/- 0.2	4.0 +/- 0.2	4.0 +/- 0.2	4.0 +/- 0.2	4.0 +/- 0.2
t	Total Tape Thickness	0.7 +/- 0.2	0.7 +/- 0.2	0.7 +/- 0.2	0.7 +/- 0.2	0.7 +/- 0.2
U	Undercrimp Width	8.0 Max	8.0 Max	8.0 Max	8.0 Max	8.0 Max
p	Component Alignment	3° Max	3° Max	3° Max	3° Max	3° Max

Part Numbering System

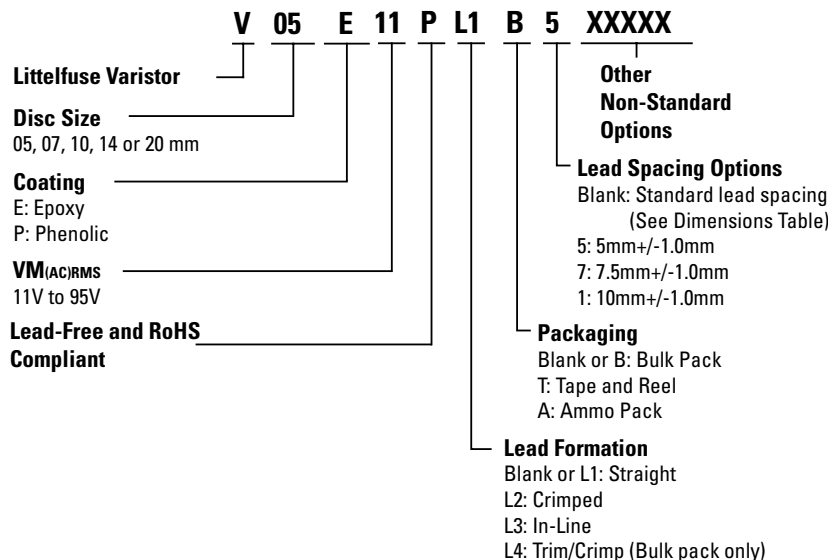

OPTION CODES:
 X2855: Nickel Barrier Coated Wire Option --
 All standard parts use tinned copper clad steel wire. Nickel Barrier Coated wire is available as an option, consisting of Copper wire with a flashing of Nickel followed by a top coating of Tin. To order append standard model BASE PART number with "X2855".
 Example:
 Standard Model: V05P11P Order As: V05P11PX2855

Disclaimer Notice - Information furnished is believed to be accurate and reliable. However, users should independently evaluate the suitability of and test each product selected for their own applications. Littelfuse products are not designed for, and may not be used in, all applications. Read complete Disclaimer Notice at www.littelfuse.com/disclaimer-electronics.