

LSIC1MO170E1000 1700 V N-channel, Enhancement-mode SiC MOSFET **HF** **RoHS** **Pb**

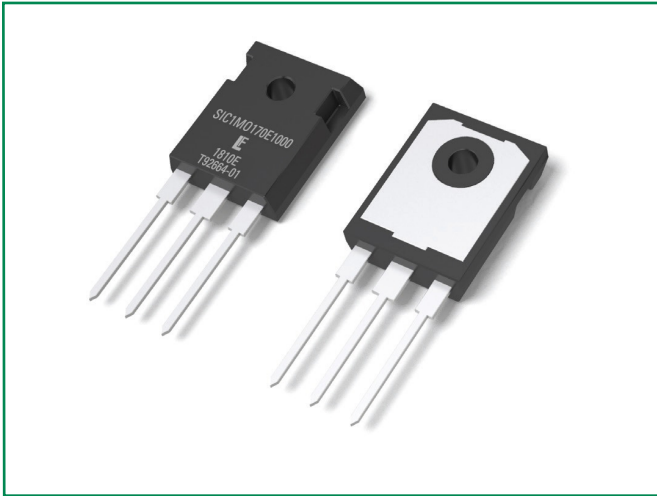

Product Summary

Characteristics	Value	Unit
V_{DS}	1700	V
Typical $R_{DS(ON)}$	750	mΩ
I_D ($T_c \leq 100\text{ }^\circ\text{C}$)	3.5	A

Circuit Diagram TO-247-3L

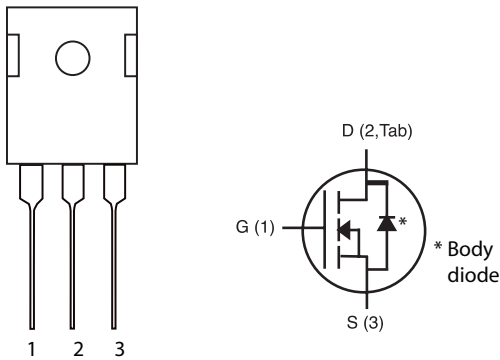

Features

- Optimized for high-frequency, high-efficiency applications
- Extremely low gate charge and output capacitance
- Low gate resistance for high-frequency switching
- Normally-off operation at all temperatures
- Ultra-low on-resistance

Environmental

- Littelfuse "RoHS" logo = **RoHS**
RoHS conform
- Littelfuse "HF" logo = **HF**
Halogen Free
- Littelfuse "Pb-free" logo = **Pb**
Pb-free lead plating

Applications

- High-frequency applications
- Solar Inverters
- Switch Mode Power Supplies
- UPS
- Motor Drives
- High Voltage DC/DC Converters
- Battery Chargers
- Induction Heating

Maximum Ratings

Characteristics	Symbol	Conditions	Value	Unit
Continuous Drain Current	I_D	$V_{GS} = 20\text{ V}, T_C = 25\text{ }^\circ\text{C}$	5.0	A
		$V_{GS} = 20\text{ V}, T_C = 100\text{ }^\circ\text{C}$	3.5	
Pulsed Drain Current ¹	$I_{D(pulse)}$	$T_C = 25\text{ }^\circ\text{C}$	15	A
Power Dissipation	P_D	$T_C = 25\text{ }^\circ\text{C}, T_J = 150\text{ }^\circ\text{C}$	54	W
Operating Junction Temperature	T_J		-55 to 150	$^\circ\text{C}$
Gate-source Voltage	$V_{GS,MAX}$	Absolute maximum values	-6 to 22	V
	$V_{GS,OPTR}$	Transient, <1% duty cycle	-10 to 25	
	$V_{GS,OP}$	Recommended DC operating values	-5 to 20	
Storage Temperature	T_{STG}	-	-55 to 150	$^\circ\text{C}$
Lead Temperature for Soldering	T_{sold}	-	260	$^\circ\text{C}$
Mounting Torque	M_D	M3 or 6-32 screw	0.6	Nm
			5.3	in-lb

Footnote 1: Pulse width limited by $T_{J,max}$

Thermal Characteristics

Characteristics	Symbol	max	Unit
Maximum Thermal Resistance, junction-to-case	$R_{\theta JC}$	2.3	$^\circ\text{C/W}$
Maximum Thermal Resistance, junction-to-ambient	$R_{\theta JA}$	40	$^\circ\text{C/W}$

Electrical Characteristics ($T_J = 25\text{ }^\circ\text{C}$ unless otherwise specified)

Characteristics	Symbol	Conditions	Min	Typ	Max	Unit
Static Characteristics						
Drain-source Breakdown Voltage	$V_{(BR)DSS}$	$V_{GS} = 0\text{ V}, I_D = 250\text{ }\mu\text{A}$	1700	-	-	V
Zero Gate Voltage Drain Current	I_{DSS}	$V_{DS} = 1700\text{ V}, V_{GS} = 0\text{ V}$	-	0.05	10	μA
		$V_{DS} = 1700\text{ V}, V_{GS} = 0\text{ V}, T_J = 150\text{ }^\circ\text{C}$	-	0.10	-	
Gate Leakage Current	$I_{GSS,F}$	$V_{GS} = 22\text{ V}, V_{DS} = 0\text{ V}$	-	-	100	nA
	$I_{GSS,R}$	$V_{GS} = -6\text{ V}, V_{DS} = 0\text{ V}$	-	-	100	
Drain-source On-state Resistance	$R_{DS(ON)}$	$I_D = 2\text{ A}, V_{GS} = 20\text{ V}$	-	750	1000	m Ω
		$I_D = 2\text{ A}, V_{GS} = 15\text{ V}$	-	1000	-	
		$I_D = 2\text{ A}, V_{GS} = 20\text{ V}, T_J = 150\text{ }^\circ\text{C}$	-	1450	-	
Gate Threshold Voltage	$V_{GS(th)}$	$V_{DS} = V_{GS}, I_D = 1\text{ mA}$	1.8	2.5	4.0	V
		$V_{DS} = V_{GS}, I_D = 1\text{ mA}, T_J = 150\text{ }^\circ\text{C}$	-	1.6	-	
Gate Resistance	R_G	Resonance method, Drain-Source shorted	-	5.8	-	Ω

Electrical Characteristics ($T_J = 25\text{ }^\circ\text{C}$ unless otherwise specified)

Characteristics	Symbol	Conditions	Value			Unit
			Min	Typ	Max	
Dynamic Characteristics						
Turn-on Switching Energy	E_{ON}	$V_{DD} = 1200\text{ V}, I_D = 2\text{ A},$ $V_{GS} = -5/+20\text{ V}, R_{G,ext} = 20\text{ }\Omega,$ $L = 1.4\text{ mH}$	-	59	-	μJ
Turn-off Switching Energy	E_{OFF}		-	25	-	
Total Per-cycle Switching Energy	E_{TS}		-	84	-	
Input Capacitance	C_{ISS}	$V_{DD} = 1000\text{ V}, V_{GS} = 0\text{ V},$ $f = 1\text{ MHz}, V_{AC} = 25\text{ mV}$	-	200	-	pF
Output Capacitance	C_{OSS}		-	11	-	
Reverse Transfer Capacitance	C_{RSS}		-	2	-	
C_{OSS} Stored Energy	E_{OSS}		-	5.3	-	
Total Gate Charge	Q_g	$V_{DD} = 1200\text{ V}, I_D = 2\text{ A},$ $V_{GS} = -5/+20\text{ V}$	-	15	-	nC
Gate-source Charge	Q_{gs}		-	3	-	
Gate-drain Charge	Q_{gd}		-	7	-	
Turn-on Delay Time	$t_{d(on)}$	$V_{DD} = 1200\text{ V}, V_{GS} = -5/+20\text{ V},$ $I_D = 2\text{ A}, R_{G,ext} = 20\text{ }\Omega,$ $R_L = 600\text{ }\Omega,$ Timing relative to V_{DS}	-	9	-	ns
Rise Time	t_r		-	15	-	
Turn-off Delay Time	$t_{d(off)}$		-	17	-	
Fall Time	t_f		-	50	-	

Reverse Diode Characteristics

Characteristics	Symbol	Conditions	Value			Unit
			Min	Typ	Max	
Diode Forward Voltage	V_{SD}	$I_S = 1\text{ A}, V_{GS} = 0\text{ V}$	-	3.7	-	V
		$I_S = 1\text{ A}, V_{GS} = 0\text{ V}, T_J = 150\text{ }^\circ\text{C}$	-	3.4	-	
Continuous Diode Forward Current	I_S	$V_{GS} = 0\text{ V}, T_C = 25\text{ }^\circ\text{C}$	-	-	8	A
Peak Diode Forward Current ¹	I_{SP}		-	-	15	

Footnote 1: Pulse width limited by $T_{J,max}$

Figure 1: Maximum Power Dissipation ($T_J = 150^\circ\text{C}$)

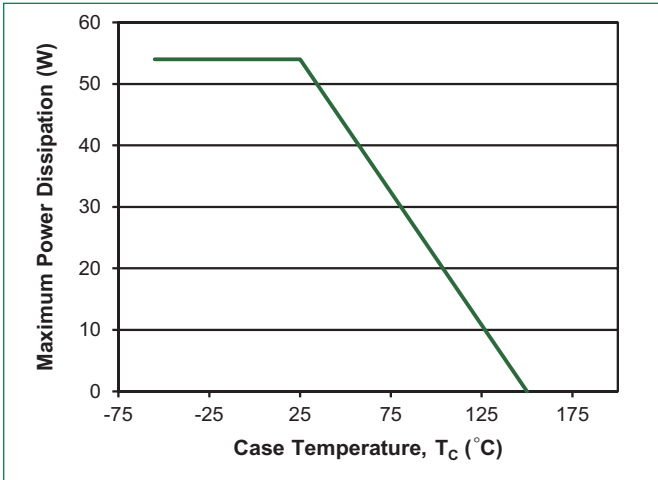

Figure 2: Transfer Characteristics ($V_{DS} = 10\text{ V}$)

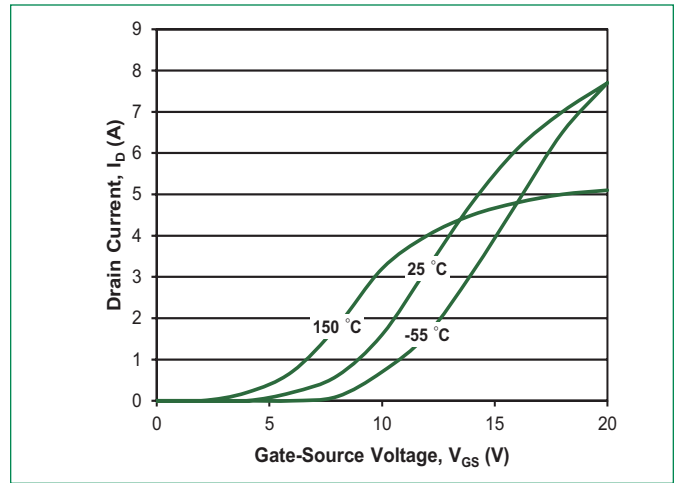

Figure 3: Output Characteristics ($T_J = 25^\circ\text{C}$)

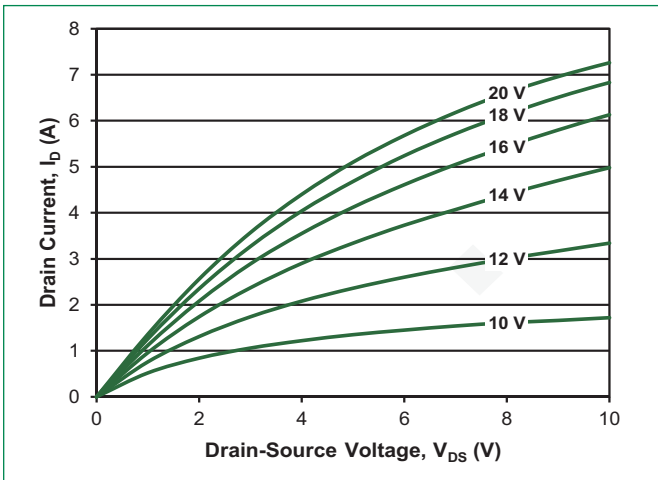

Figure 4: Output Characteristics ($T_J = 150^\circ\text{C}$)

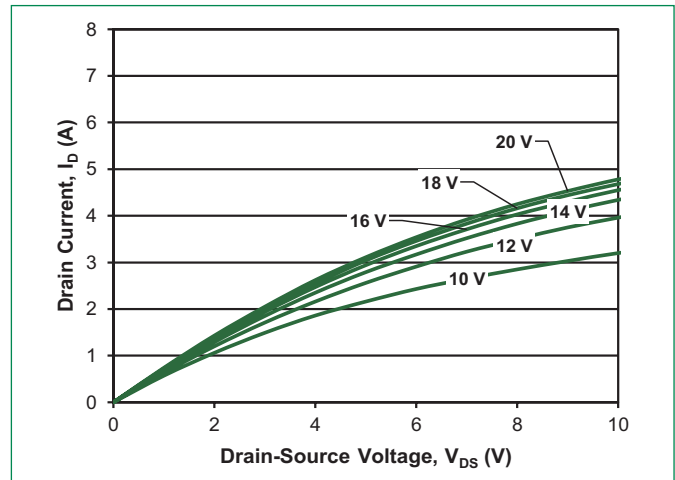

Figure 5: Output Characteristics ($T_J = -55^\circ\text{C}$)

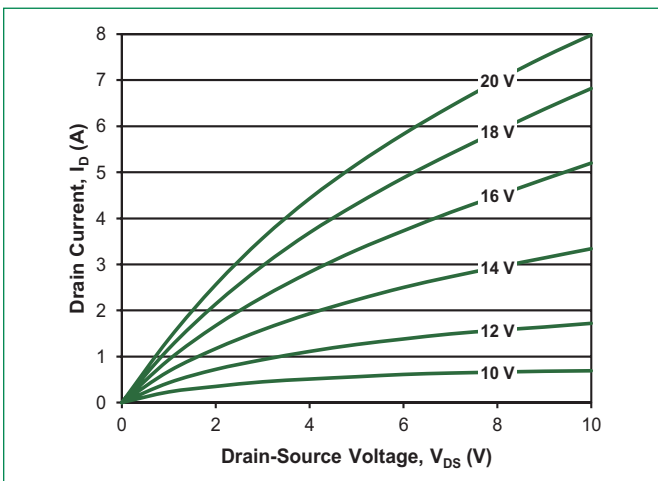

Figure 6: Reverse Conduction Characteristics ($T_J = 25^\circ\text{C}$)

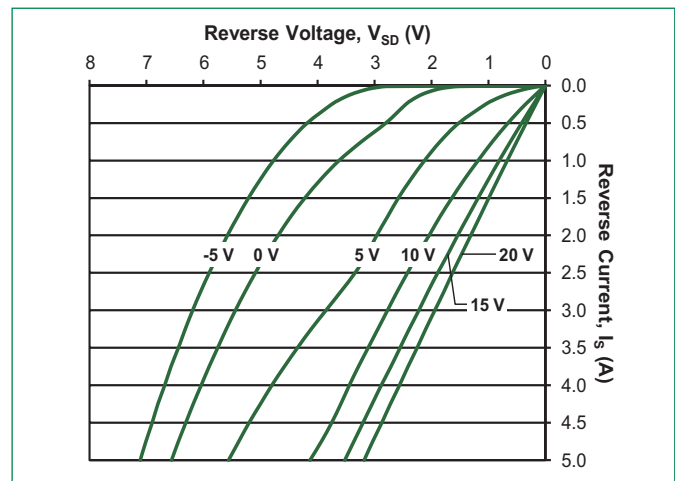

Figure 7: Reverse Conduction Characteristics ($T_J = 150\text{ }^\circ\text{C}$)

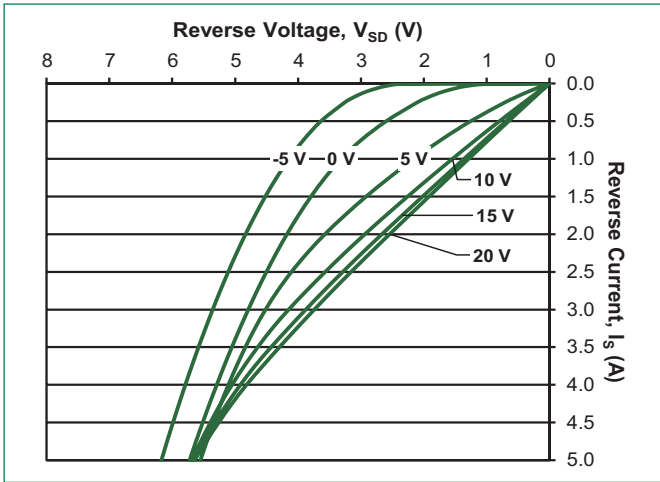

Figure 8: Reverse Conduction Characteristics ($T_J = -55\text{ }^\circ\text{C}$)

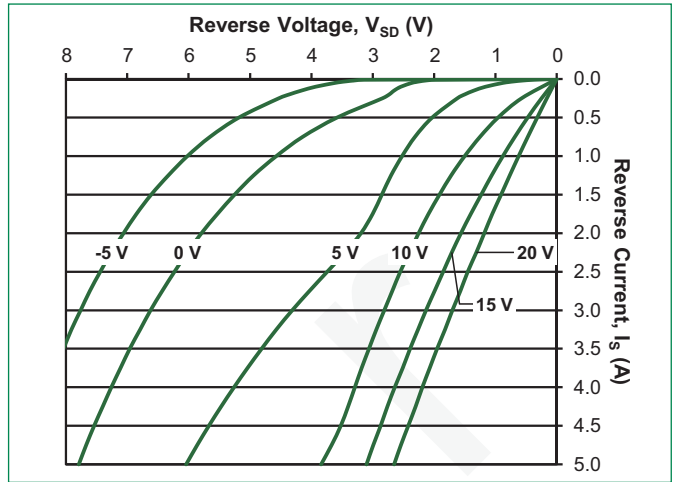

Figure 9: Transient Thermal Impedance

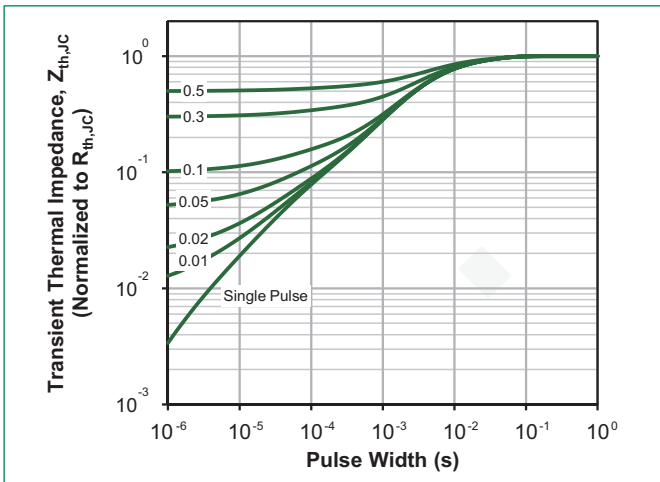

Figure 10: Safe Operating Area ($T_c = 25\text{ }^\circ\text{C}$)

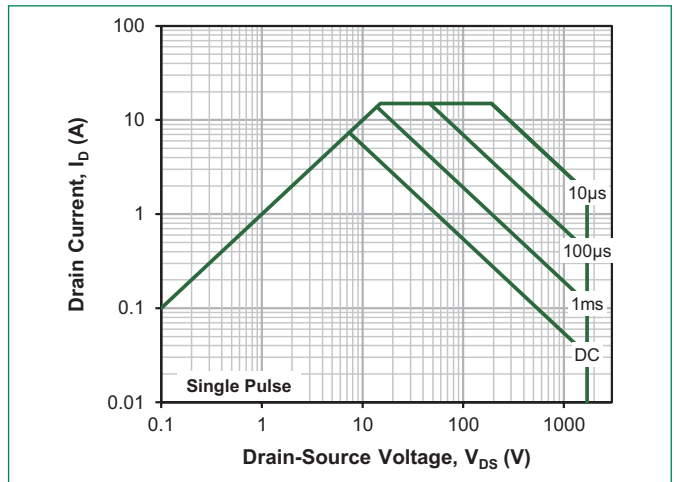

Figure 11: On-resistance vs. Drain Current

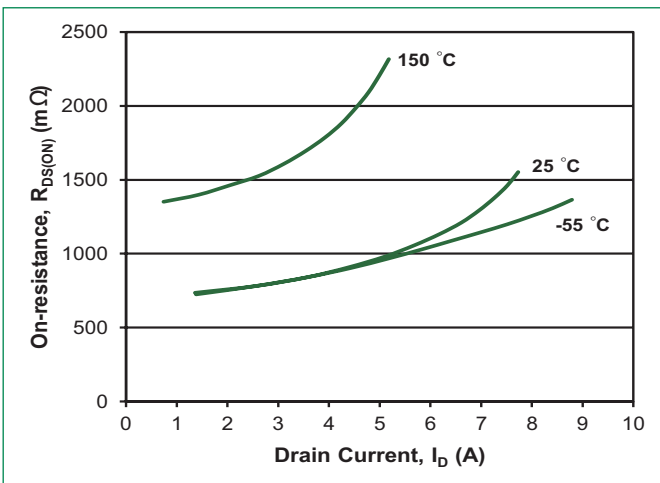

Figure 12: Normalized On-resistance

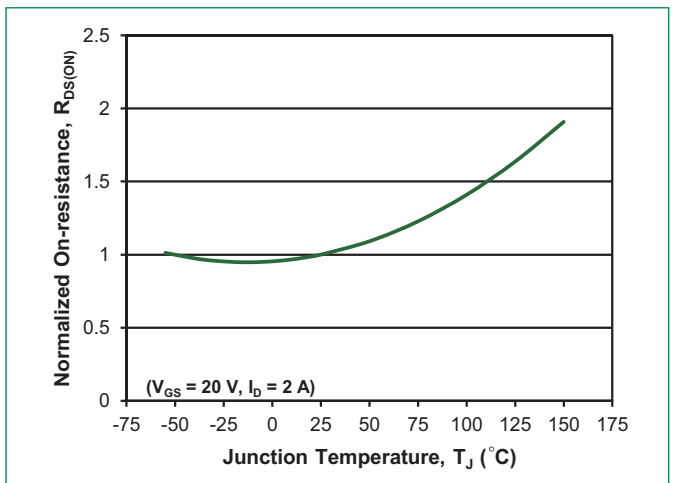

Figure 13: Threshold Voltage

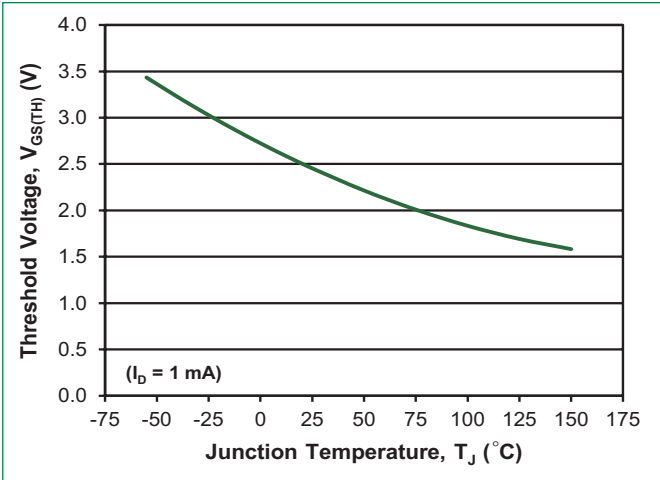

Figure 14: Drain-Source Blocking Voltage

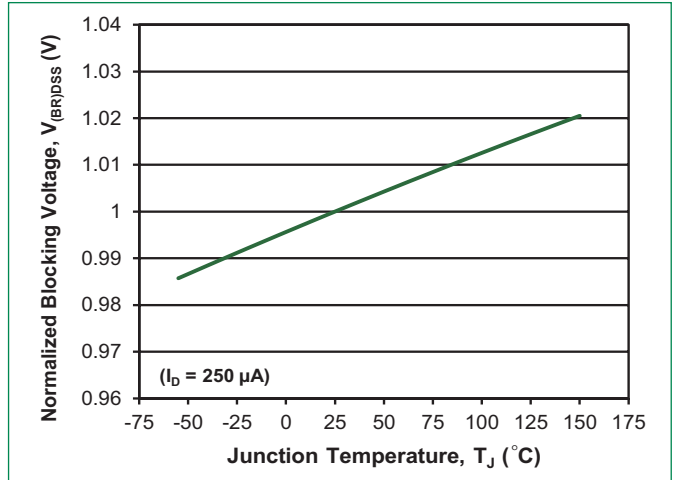

Figure 15: Junction Capacitances

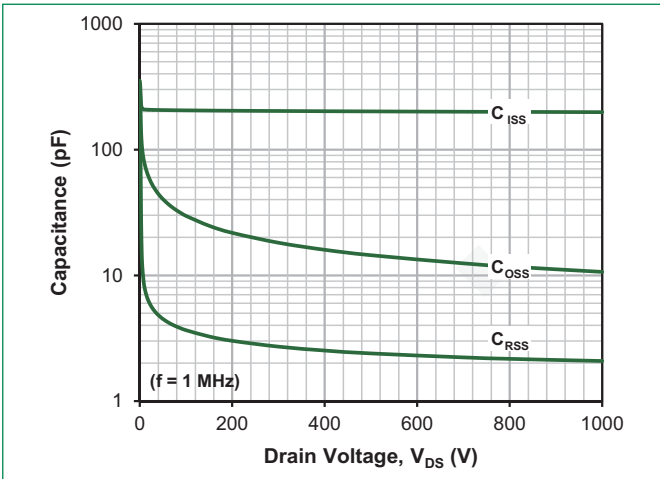

Figure 16: Junction Capacitances

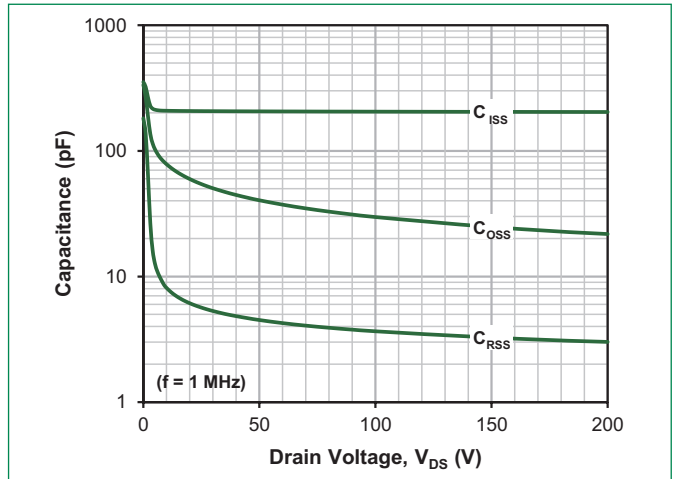

Figure 17: C_{OSS} Stored Energy E_{OSS}

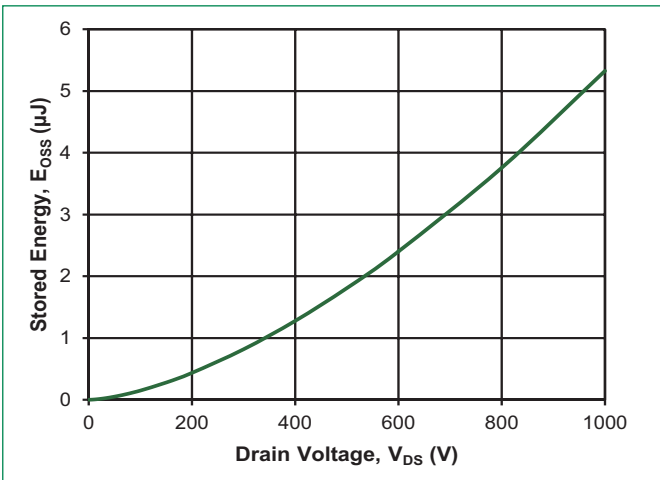

Figure 18: Gate Charge

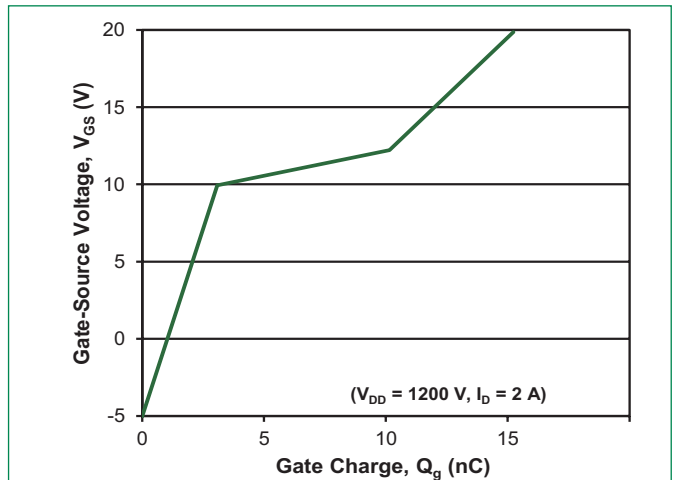

Figure 19: Switching Energy vs. Drain Current

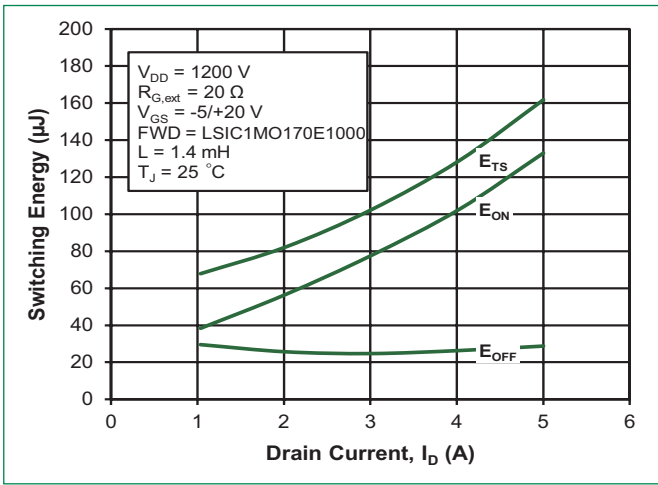
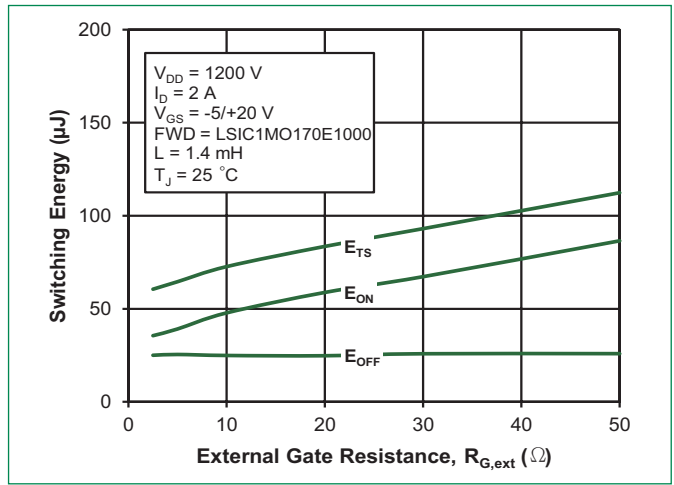
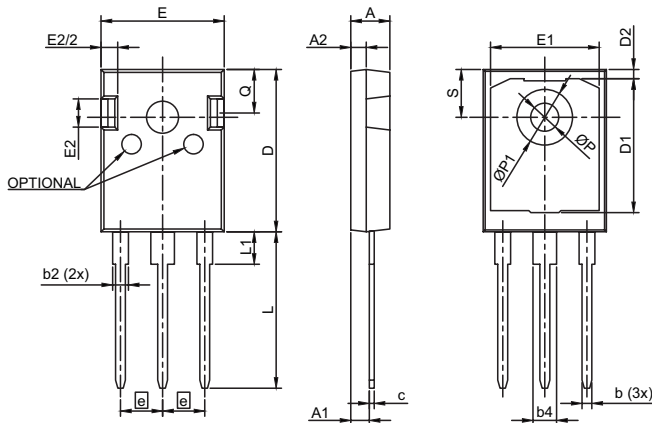

Figure 20: Switching Energy vs. Gate Resistance



Package Dimensions TO-247-3L



Recommended Hole Pattern Layout

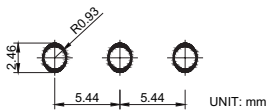

Notes:

1. Dimensions are in millimeters
2. Dimension D, E do not include mold flash. Mold flash shall not exceed 0.127 mm per side. These measured at the outermost extreme of plastic body.
3. ØP to have a maximum draft angle of 1.5° to the top of the part with a maximum hole diameter of 0.154"

Symbol	Millimeters		
	Min	Nom	Max
A	4.80	5.03	5.20
A1	2.25	2.38	2.54
A2	1.85	1.98	2.11
b	0.99	-	1.40
b2	1.65	-	2.39
b4	2.59	-	3.43
c	0.38	0.64	0.89
D	20.80	20.96	21.34
D1	13.50	-	-
D2	0.51	1.19	1.35
e	5.44 BSC		
E	15.75	15.90	16.13
E1	13.06	14.02	14.15
E2	4.19	4.32	4.83
L	19.81	20.19	20.57
L1	3.81	4.19	4.45
ØP	3.55	3.61	3.66
ØP1	7.06	7.19	7.32
Q	5.49	5.61	6.20
S	6.05	6.17	6.30

Part Numbering and Marking System

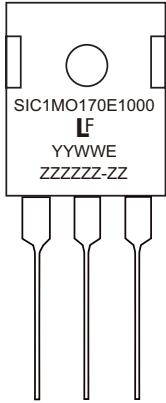

SIC = SiC
1 = Gen1
MO = MOSFET
170 = Voltage Rating (1700 V)
E = TO-247-3L
1000 = $R_{DS(ON)}$ (1000 mOhm)
YY = Year
WW = Week
E = Special Code
ZZZZZZ-ZZ = Lot Number

Packing Options

Part Number	Marking	Packing Mode	M.O.Q
LSIC1MO170E1000	SIC1MO170E1000	Tube (30pcs)	450

Packing Specification TO-247-3L

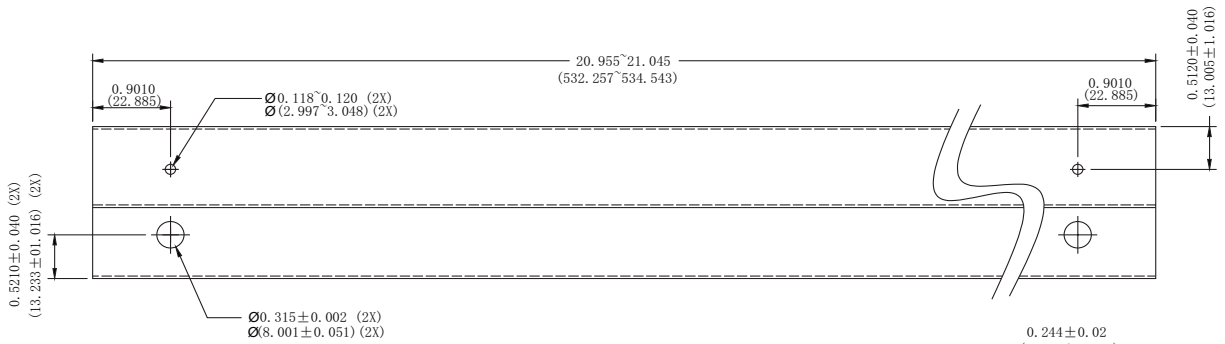

NOTE:

1. All pin plug holes are considered critical dimension
2. Tolerance is to be ± 0.010 unless otherwise specified
3. Dimension are in inches (and millimeters).

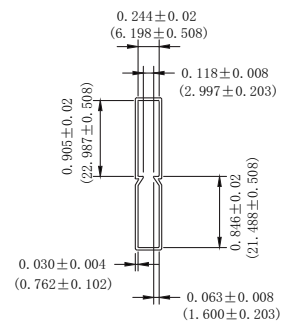

Disclaimer Notice - Littelfuse products are not designed for, and shall not be used for, any purpose (including, without limitation, automotive, military, aerospace, medical, life-saving, life-sustaining or nuclear facility applications, Components intended for surgical implant into the body, or any other application in which the failure or lack of desired operation of the product may result in personal injury, death, or property damage) other than those expressly set forth in applicable Littelfuse product documentation. Warranties granted by Littelfuse shall be deemed void for products used for any purpose not expressly set forth in applicable Littelfuse documentation. Littelfuse shall not be liable for any claims or damages arising out of products used in applications not expressly intended by Littelfuse as set forth in applicable Littelfuse documentation. The sale and use of Littelfuse products is subject to Littelfuse Terms and Conditions of Sale, unless otherwise agreed by Littelfuse. Information furnished is believed to be accurate and reliable. However, users should independently evaluate the suitability of and test each product selected for their own applications. Littelfuse products are not designed for, and may not be used in, all applications. Read complete Disclaimer Notice at www.littelfuse.com/disclaimer-electronics.