

High Power White LEDs

SFT-40-WxS

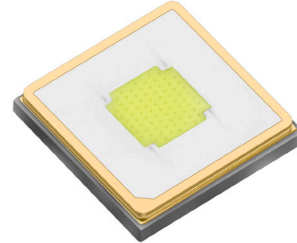

Table of Contents

Ordering Part Numbers.	2
Binning Information.	3
Chromaticity Binning Structure	4
Product Characteristics.	6
Soldering Profile	9
Precautions for Use.	10
Mechanical Dimensions	11
Tape and Reel.	12
Packaging and Labeling	13

Features

The flat window of an SFT White LED results in a much smaller light emitting surface than a dome-shaped cover, enabling much smaller optics and higher optical coupling efficiency. Along with the high lumen density of a monolithic emitter, SFT white series is a powerful light source for beam pattern critical lighting applications, in delivery of extremely high intensity, long beam distance and tight beam angles.

- Cool white LEDs with a maximum output in excess of 2200 lm @8A, 85°C.
- High lumen density up to 588 lm/mm² (6500K)
- Maximum Drive Current: 8 A
- Luminous Efficacy: typ. 171 lm/W @ 700 mA, 85°C (6500K)
- Color Temperature: 5000K, 5700K, 6500K
- Color Rendering Index: min. 65, typ. 70
- Low thermal resistance: 0.7° C/W
- ANSI-compatible chromaticity bins
- Electrically isolated thermal path
- 8 kV HBM ESD rating per ANSI/ESDA/JEDEC JS-001
- RoHS and REACH compliant

Applications

- | | |
|---|--|
| <ul style="list-style-type: none"> • Portable Lights • Bicycle Lights • Automotive Auxiliary Lights • LED Work Lights | <ul style="list-style-type: none"> • Outdoor and Roadway Lighting • High Bay Industrial Lighting • Entertainment Lighting • Directional Light Fixtures |
|---|--|

Ordering Part Numbers

CCT	Minimum Flux Bin ¹	Minimum Flux (lm)	Chromaticity Bin Kit Code ²	Ordering Part Numbers
6500K	N4	594	651	SFT-40-W65S-F50-N4651
			652	SFT-40-W65S-F50-N4652
	N5	634	651	SFT-40-W65S-F50-N5651
			652	SFT-40-W65S-F50-N5652
5700K	Please contact Luminus Sales for details			
5000K				

Notes

1. The Ordering Part Number specifies the Minimum Flux Bin in shipment; higher flux bins may be shipped without advance notice. Please refer to 'Luminous Flux Binning' table for details of all flux bins.
2. Shipments always adhere to the color bins specified in each Chromaticity Bin Kit. See 'Chromaticity Bin Kit Codes' table for the color bins included in each Bin Kit.

Part Number Nomenclature

SFT — 40 — W<xx> — F50 — <ffcc>

Product Family	Light Emission Area	Light Color	Package Configuration	Bin Kit
S: Surface Mount F: Flat Window T: Single Emitter	40: 4.0 mm ²	W: White <xx> Color Temperature 50: 5000K 65: 6500K <y> CRI Category Code S: CRI>65	F50: Package Code	<ff> Minimum Flux Bin, see 'Luminus Flux Binning' table for details <ccc> Chromaticity Bin Kit, see 'Chromaticity Bin Kit Codes' table for details

Luminous Flux Binning

Flux Bin Code	Binning @ 1500 mA, T _j =85°C ¹		@ 700 mA, T _j =25°C ²	Correlated Minimum Flux (lm) @ T _j =85°C ²					
	Minimum Flux (lm)	Maximum Flux (lm)	Minimum Flux (lm)	700 mA	2000 mA	3000 mA	5000 mA	6000mA	8000 mA
N3	554	594	316	283	709	986	1446	1640	1985
N4	594	634	339	303	760	1057	1550	1758	2128
N5	634	673	362	323	812	1129	1655	1877	2272
P2	673	713	384	343	861	1198	1757	1992	2411
P3	713	763	407	364	913	1269	1861	2110	2555

Notes

- LEDs are measured at 25°C ambient temperature with 1500 mA 20ms single pulse. The measured values are correlated to 1500mA at 85°C junction temperature (T_j). Luminus maintains a ±6% tolerance on flux measurement.
- Flux values at other junction temperature (T_j) and/or forward current conditions are calculated and for reference only.

Forward Voltage Binning

Voltage Bin Code	Binning @ 1500mA, T _j =85°C	
	Minimum Voltage (V)	Maximum Voltage (V)
VH	2.5	2.7
VJ	2.7	2.9
VK	2.9	3.1

Note: Individual voltage bins are not orderable.

Chromaticity Binning Coordinates

CCT	Bin Code	CIE _x	CIE _y	Bin Code	CIE _x	CIE _y	Bin Code	CIE _x	CIE _y	Bin Code	CIE _x	CIE _y
6500K	BA	0.3048	0.3207	BB	0.3028	0.3304	BC	0.3115	0.3391	BD	0.3130	0.3290
		0.3130	0.3290		0.3115	0.3391		0.3205	0.3481		0.3213	0.3373
		0.3144	0.3186		0.3130	0.3290		0.3213	0.3373		0.3221	0.3261
		0.3068	0.3113		0.3048	0.3207		0.3130	0.3290		0.3144	0.3186
	BH	0.3068	0.3113	BE	0.3005	0.3415	BF	0.3099	0.3509	BG	0.3144	0.3186
		0.3144	0.3186		0.3099	0.3509		0.3196	0.3602		0.3221	0.3261
		0.3161	0.3059		0.3115	0.3391		0.3205	0.3481		0.3231	0.3120
		0.3093	0.2993		0.3028	0.3304		0.3115	0.3391		0.3161	0.3059
5700K	CA	0.3215	0.3350	CB	0.3207	0.3462	CC	0.3290	0.3538	CD	0.3290	0.3417
		0.3290	0.3417		0.3290	0.3538		0.3376	0.3616		0.3371	0.3490
		0.3290	0.3300		0.3290	0.3417		0.3371	0.3490		0.3366	0.3369
		0.3222	0.3243		0.3215	0.3350		0.3290	0.3417		0.3290	0.3300
	CH	0.3222	0.3243	CE	0.3196	0.3602	CF	0.3290	0.3690	CG	0.3290	0.3300
		0.3290	0.3300		0.3290	0.3690		0.3381	0.3762		0.3366	0.3369
		0.3290	0.3180		0.3290	0.3538		0.3376	0.3616		0.3361	0.3245
		0.3231	0.3120		0.3207	0.3462		0.3290	0.3538		0.3290	0.3180
5000K	DA	0.3371	0.3490	DB	0.3376	0.3616	DC	0.3463	0.3687	DD	0.3451	0.3554
		0.3451	0.3554		0.3463	0.3687		0.3551	0.3760		0.3533	0.3620
		0.3440	0.3427		0.3451	0.3554		0.3533	0.3620		0.3515	0.3487
		0.3366	0.3369		0.3371	0.3490		0.3451	0.3554		0.3440	0.3427
	DH	0.3366	0.3369	DE	0.3381	0.3762	DF	0.3480	0.3840	DG	0.3440	0.3428
		0.3440	0.3428		0.3480	0.3840		0.3571	0.3907		0.3515	0.3487
		0.3429	0.3307		0.3463	0.3687		0.3551	0.3760		0.3495	0.3339
		0.3361	0.3245		0.3376	0.3616		0.3463	0.3687		0.3429	0.3307

Chromaticity Binning Diagram

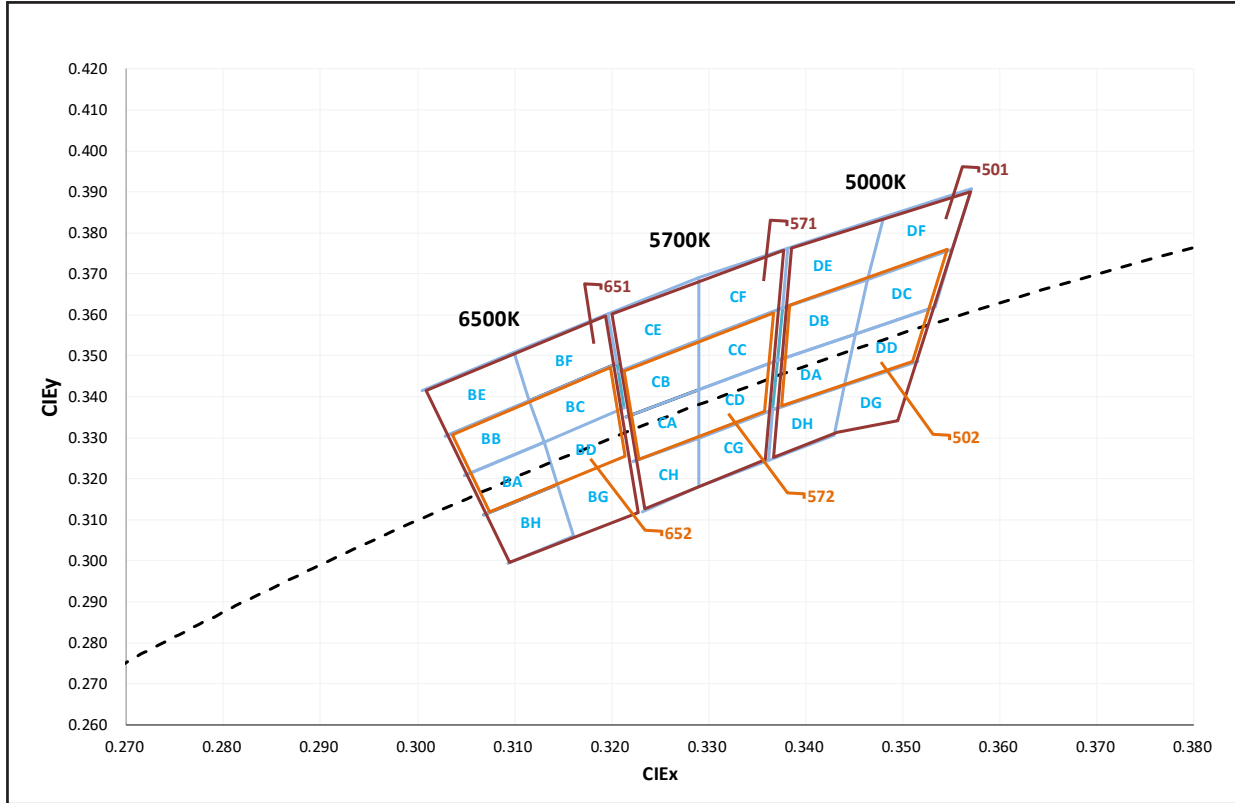

Chromaticity Bin Kit Codes

CCT	Bin Kit	Chromaticity Bins
5000K	501	DA, DB, DC, DD, DE, DF, DG, DH
	502	DA, DB, DC, DD
5700K	571	CA, CB, CC, CD, CE, CF, CG, CH
	572	CA, CB, CC, CD
6500K	651	BA, BB, BC, BD, BE, BF, BG, BH
	652	BA, BB, BC, BD

Note: Luminus maintains a tolerance of ± 0.005 on chromaticity (CIE_x, CIE_y), and ± 2 on Color Rendering Index (CRI) measurements.

Product Characteristics

Parameter	Symbol	Minimum	Typical	Maximum	Unit
Viewing Angle (FWHM)	$2\theta_{1/2}$		120		Degree
Color Rendering Index	CRI	65	70		
Thermal resistance (Electrical) Junction/Solder Point	$R_{thjs-EL}$		0.7		°C/W
Junction Temperature	T_j			150	°C
Forward Voltage (@ $I_f=1500$ mA, $T_j=85^\circ\text{C}$)	V_f	2.6	2.8	3.1	V
DC Forward Current	I_f	0.1		8	A
Surge Current (t < 10 ms, Duty Cycle < 10%)	I_{s-max}			10	A
Reverse Voltage ($I_r=10$ mA)	V_r			5	V
Power Dissipation	P_d			29	W
Operating Temperature	T_{opr}	-40		100	°C
Storage Temperature	T_{stg}	-40		100	°C
ESD withstand Voltage HBM Per ANSI/ESDA/JEDEC JS-001	V_{HBM}	8			kV
ESD withstand Voltage CDM Per ANSI/ESDA/JEDEC JS-002	V_{CDM}	1			kV

Optical & Electrical Characteristics

Relative Luminous Flux vs. Forward Current

$\Phi_v/\Phi_v(1.5A), T_j = 85^\circ C$

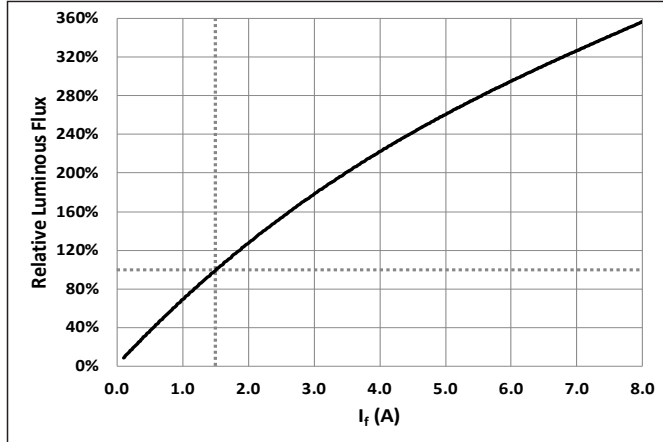

Relative Luminous Flux vs. Temperature (Tj)

$\Phi_v/\Phi_v(85^\circ C), I_f = 1.5A$

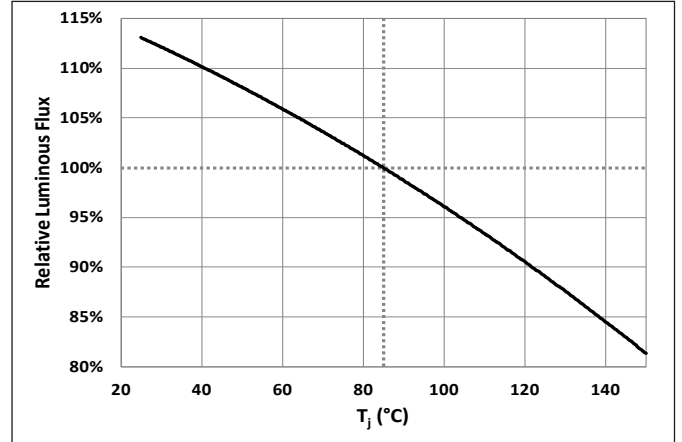

Forward Voltage vs. Forward Current

$V_f = f(I_f), T_j = 85^\circ C$

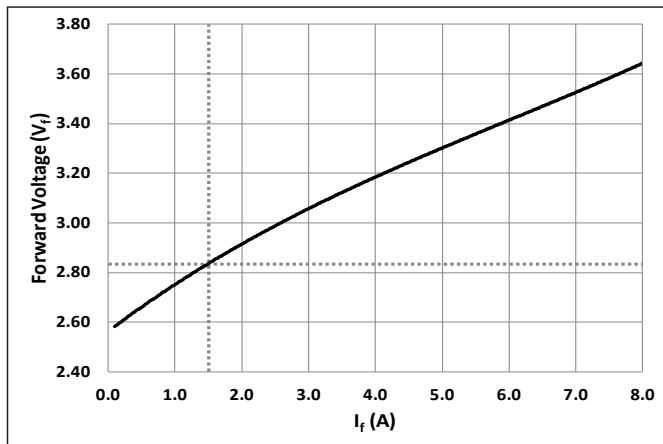

Relative Forward Voltage vs. Temperature (Tj)

$\Delta V_f = V_f(T_j) - V_f(85^\circ C), I_f = 1.5A$

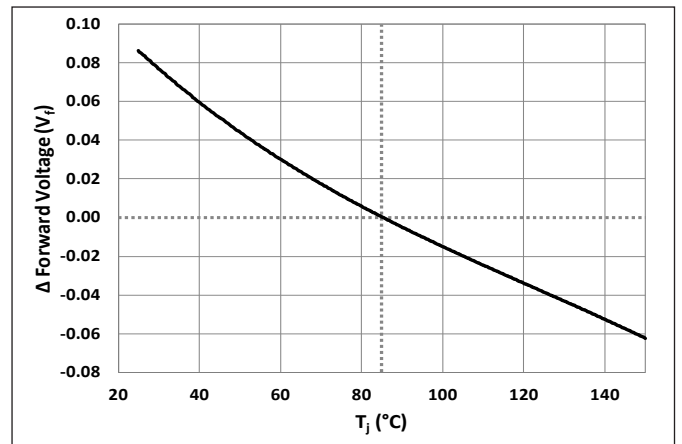

Relative Chromaticity vs. Forward Current

$\Delta CIE_{x,y} = CIE_{x,y}(I_f) - CIE_{x,y}(1.5A), T_j = 85^\circ C$

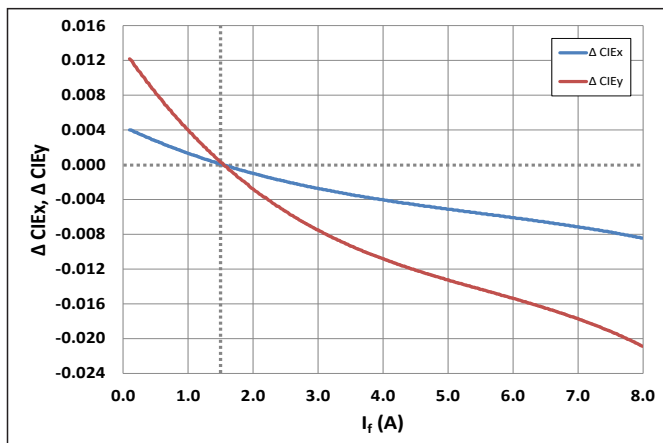

Relative Chromaticity vs. Temperature (Tj)

$\Delta CIE_{x,y} = CIE_{x,y}(T_j) - CIE_{x,y}(85^\circ C), I_f = 1.5A$

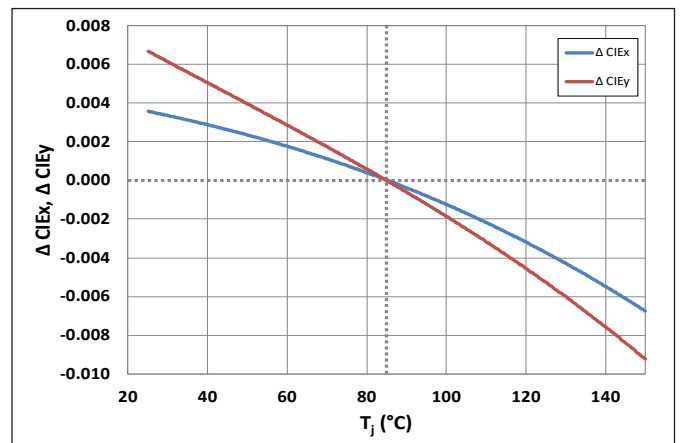

Relative Spectral Power Distribution

$I_f=1.5A, T_j=85^{\circ}C$

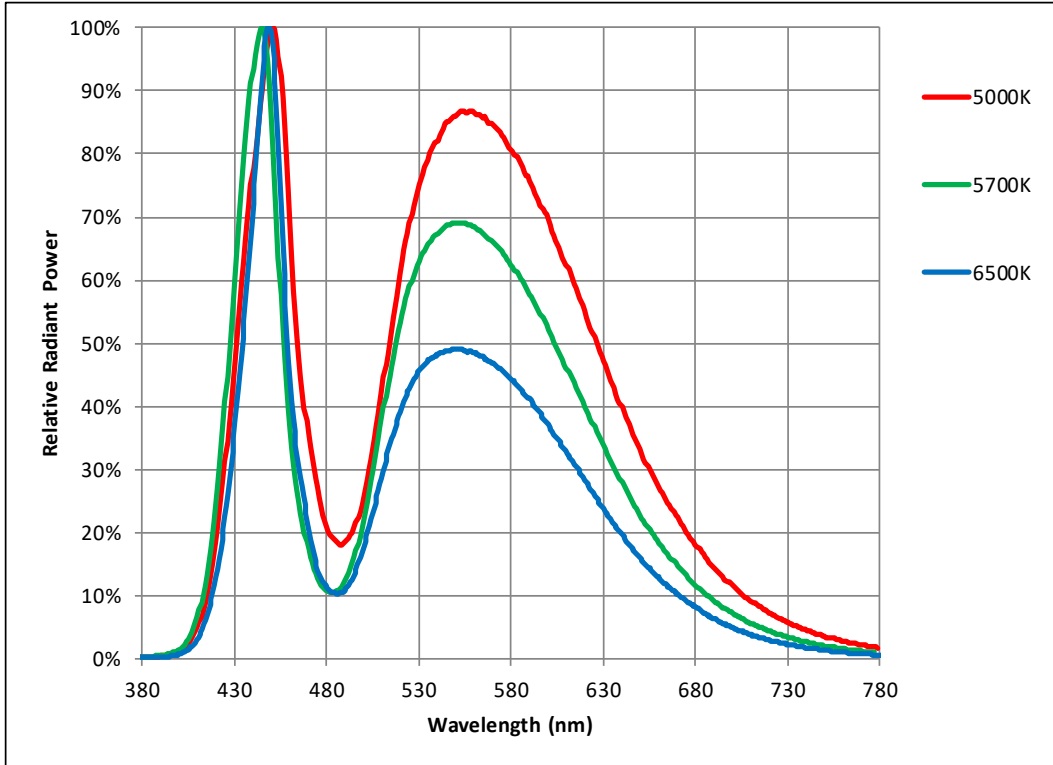

Typical Radiation Characteristics

$I_f=1.5A, T_j=25^{\circ}C$

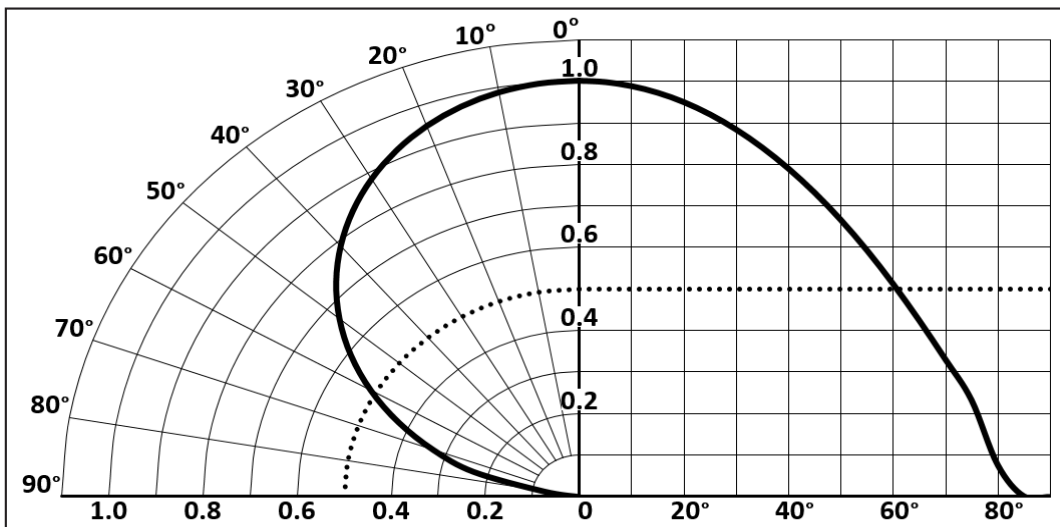

Soldering Profile

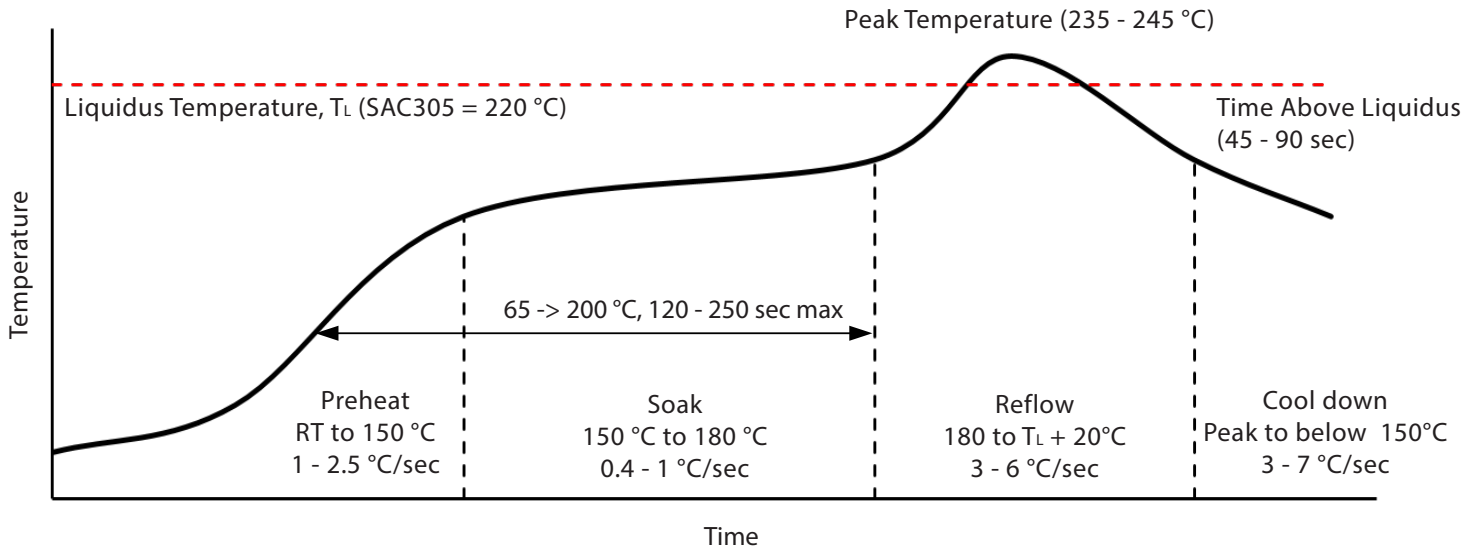

SMT Rework Guideline	Manual Hotplate Reflow	Hot Air Gun Reflow
Heating Time	< 60 sec	
Hotplate Temperature	< 245°C	< 150°C

Notes

- Product complies to Moisture Sensitivity Level 3 (MSL 3).
- The numbers in the table are specific to SAC305. Luminus recommends using an SAC305 solder paste with a no-clean flux for RoHS compliant products.
- During the pick and place process, axial forces on the dome (or window) should not exceed 0.5 Newtons (N).
- Use of a multi-zone IR reflow oven with a nitrogen blanket is recommended.
- Time-temperature profile of the reflow process showing the four functional profile zones are defined in IPC-7801. Temperature is referenced to the center of the PCB.
- Luminus recommends to use the solder paste data sheet information as a starting point in time-temperature process development.
- These are general guidelines. Consult the solder paste manufacturer's datasheet for guidelines specific to the alloy and flux combination used in your application. For more information, please refer to: <https://luminusdevices.zendesk.com/hc/en-us/articles/360060306692-How-do-I-Reflow-Solder-Luminus-SMD-Components->
- For any technical questions about soldering process, please contact Luminus at techsupport@luminus.com.

Precautions for Use

Storage:

1. Before opening the package

The LEDs should be kept at a temperature lower than 40° C and relative humidity lower than 90%. The LEDs should be used within a year. When storing the LEDs, moisture proof package with absorbent material (silica gel) is recommended.

2. After opening the package

The LEDs should be kept at a temperature lower than 30° C and relative humidity lower than 60%. The LEDs should be soldered within 168 hours (7days) after opening the moisture proof package.

If unused LEDs remain, they should be stored in moisture proof packages, such as sealed containers with moisture absorbent material (silica gel). It is also recommended to return the unused LEDs to the original moisture proof package and to seal it again.

If the moisture absorbent material (silica gel) vaporizes or passes the expiration date, baking treatment should be performed by using the following conditions : 60 °C for 20 hours.

The LED's electrode and lead frame comprise a silver plated copper alloy. The silver surface may be affected by environments. Please avoid conditions which may cause the LEDs to corrode or discolor. The corrosion or discoloration might lower solderability or affect optical characteristics.

Please avoid rapid transition in ambient temperature, especially in high humidity environments where condensation can occur.

Static Electricity:

1. The products are sensitive to static electricity, and care should be taken when handling them.

2. Static electricity or surge voltage will damage the LEDs. It is recommended to wear anti-electrostatic gloves or wristband when handling the LEDs.

3. All devices, equipment and machinery must be properly grounded. It is recommended that measures be taken against surge voltage to the equipment that mounts the LEDs.

Package Configuration

Mechanical Dimensions

All dimensions are in millimeter ± 0.13 mm

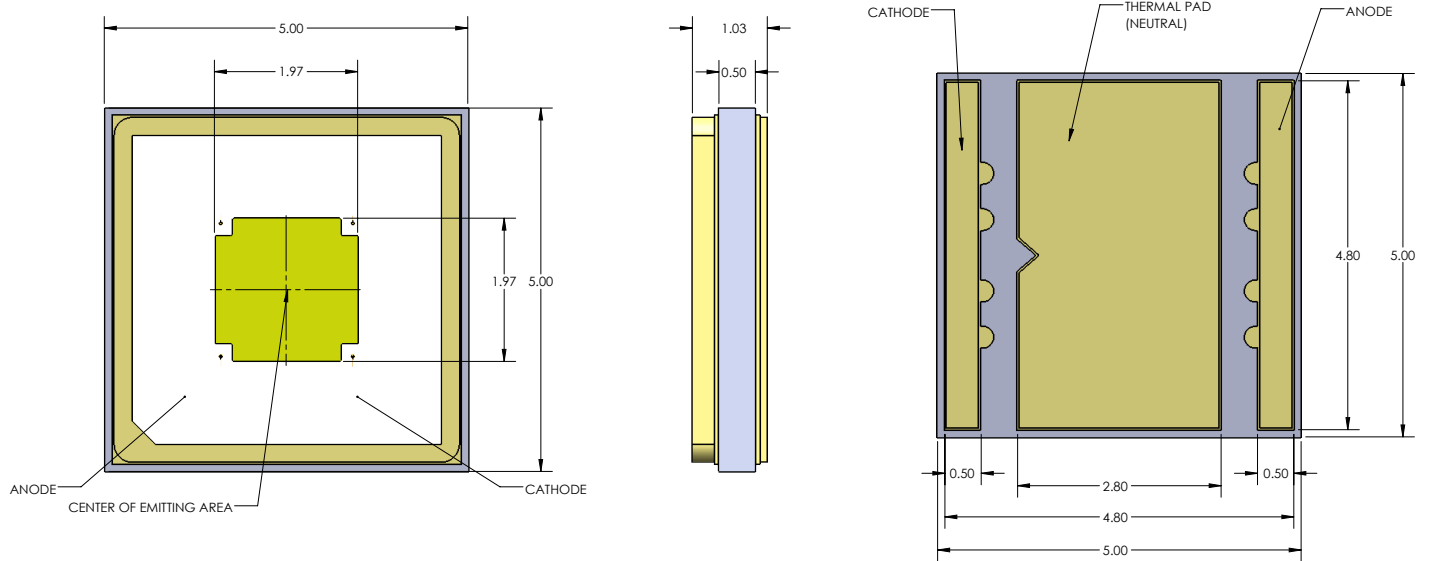

Recommended PCB Solder Pad and Stencil Pattern

All dimensions are in millimeter ± 0.13 mm

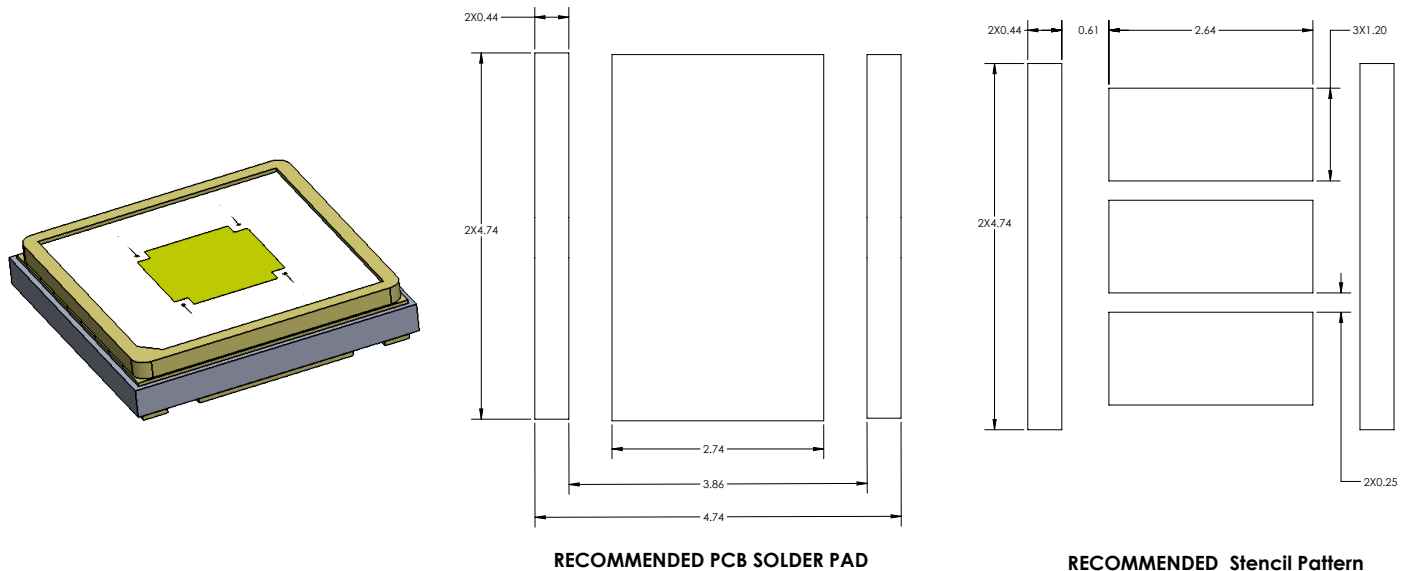

Tape and Reel

All dimensions are in millimeter ± 0.13 mm

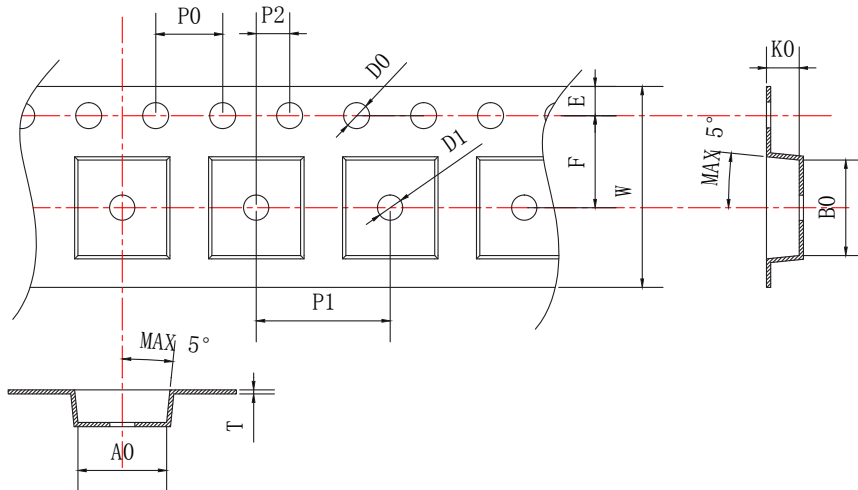

Parameter	Dimension (mm)
A0	5.3 \pm 0.1
B0	5.7 \pm 0.1
D0	1.55 \pm 0.05
D1	1.5 \pm 0.1
E	1.75 \pm 0.1
F	5.5 \pm 0.1
K0	1.95 \pm 0.1
P0	4.0 \pm 0.1
P1	8.0 \pm 0.1
P2	2.0 \pm 0.1
T	0.25 \pm 0.05
W	12 \pm 0.3

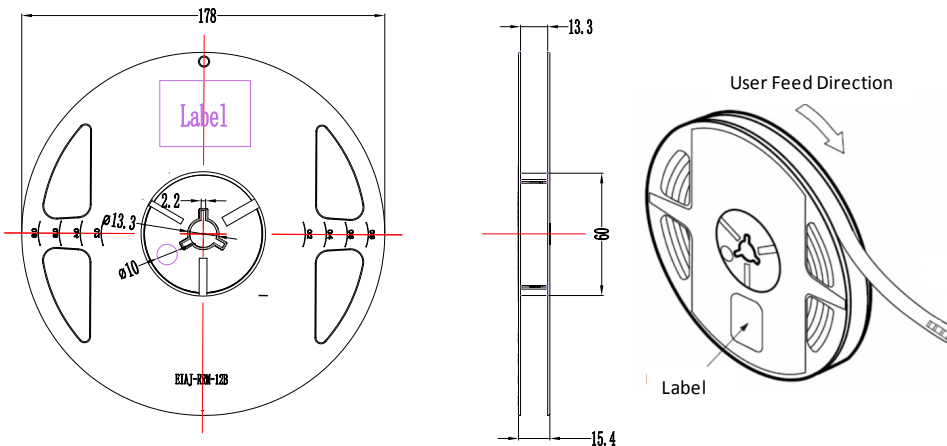

Notes:

1. Each Reel contains 500 units of LEDs.
2. Black anti-static tape material (Denka ECM3/ECAP3)
3. The accumulated tolerance for ten chain holes should be no more than 0.2 mm.
4. The tortuosity of 250 mm tape should be no more than 1 mm.
5. Leave 800 mm of type empty for lead in (100 empty pockets)
6. Leave 1200 mm of type empty for trailer (150 empty pockets)
7. All dimensions must comply to EIA-481-D
8. Final tape and reel packaging must meet the requirements of JEDEC-STD-033, LEVEL 2A.

Packaging and Labeling

Packaged Reel

Each reel contains 500 units.

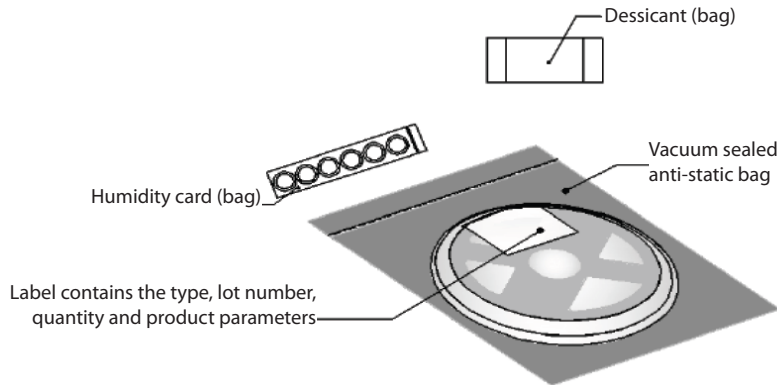

Label on Reel

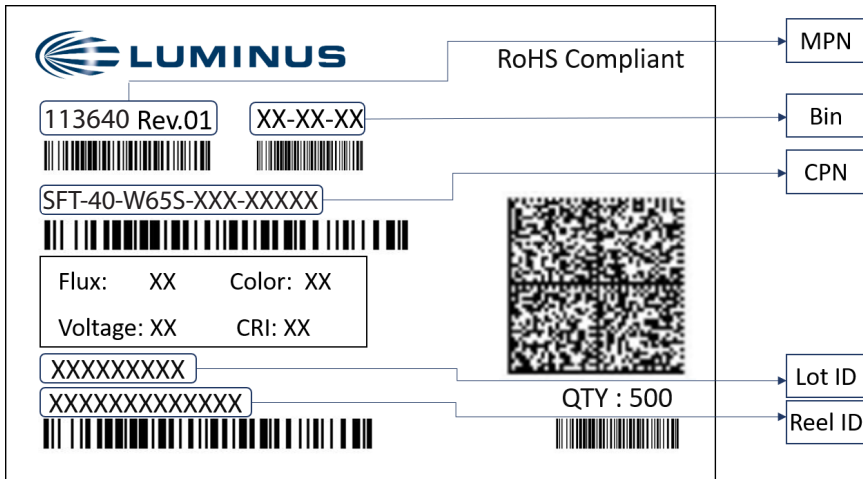

Label Information	
CPN	Luminus ordering part number
MPN	For Luminus internal use
QTY	Quantity of parts per reel
Flux	Single flux bin code (see <i>Luminous Flux Binning</i> table on page 3)
Voltage	Single voltage bin code (see <i>Forward Voltage Binning</i> table on page 3)
Color	Single chromaticity bin code (see <i>Chromaticity Bin Coordinates</i> table on page 4)
CRI	N/A
Lot ID & Reel ID	For Luminus internal use

Packaging Boxes

Box Size 1 - 5 reels per box
 Size: 22.5 x 24.5 x 6.5 cm

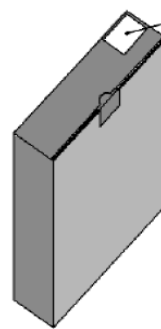
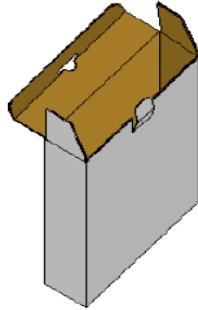

Label contains the type, lot number, quantity and product parameters

Box Size 2 - 10 reels per box
 Size: 22.5 x 24.5 x 13 cm

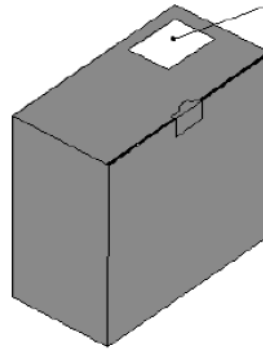
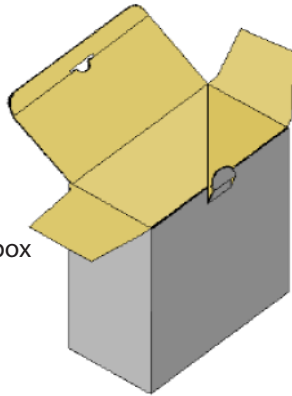

Label contains the type, lot number, quantity and product parameters

Shipping Label on Packaging Box

Multiple labels are attached to the box (one label per reel inside the box)

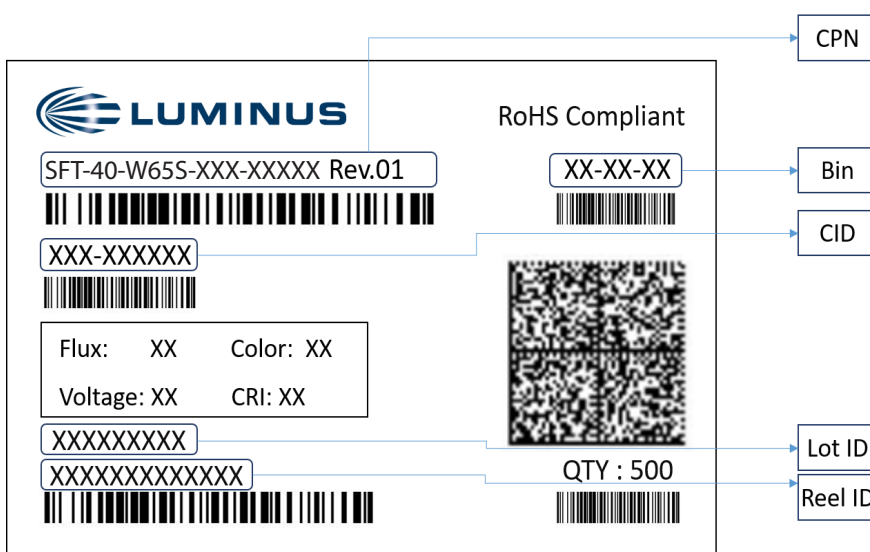

Label Information	
CPN	Luminus ordering part number
CID	Customer ID
QTY	Quantity of parts per reel
Flux	Single flux bin code (see <i>Luminous Flux Binning</i> table on page 3)
Voltage	Single voltage bin code (see <i>Forward Voltage Binning</i> table on page 3)
Color	Single chromaticity bin code (see <i>Chromaticity Bin Coordinates</i> table on page 4)
CRI	N/A
Lot ID & Reel ID	For Luminus internal use