

TEVI-AR0821

- onsemi AR0821 8MP rolling shutter camera sensor with ISP.
- Designed for low light and high dynamic range performance.
- Convenient S-Mount (M12) interchangeable lens.
- Driver integration support for :
 - NXP i.MX8 / i.MX9 Family
 - Nvidia Jetson Nano / Xavier NX / Orin
 - TI Sitara™ AM62x / Jacinto™ TDA4 Family
- Comes with VizionViewer™ SDK

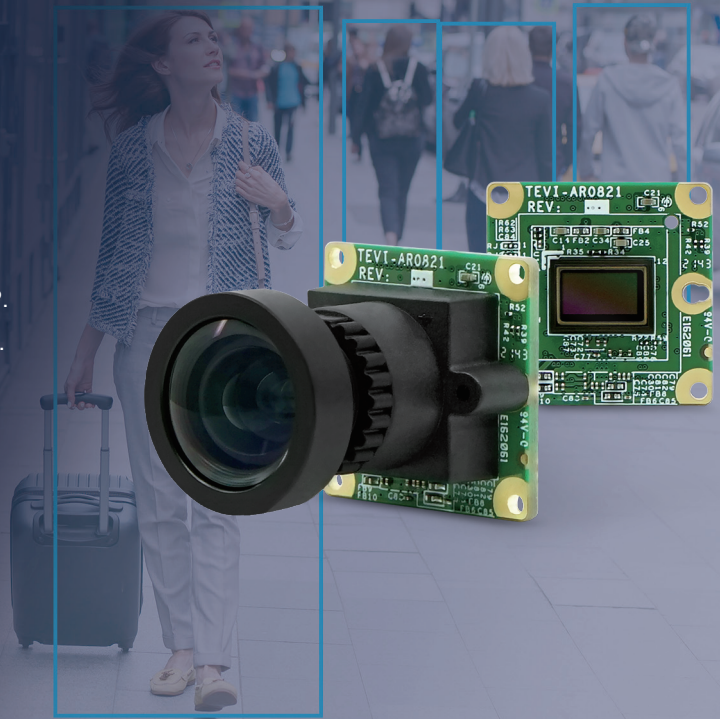

Specifications

Camera Information

CMOS Sensor	onsemi AR0821
Active Pixels	3848 (H) x 2168 (V) = 8MP
Pixel Size	2.1 μm x 2.1 μm
Optical Format	1/2" (Diagonal 9.25 mm)
Shutter Type	Rolling Shutter
Chromaticity	Color
Illuminated type	Back Side Illuminated (BSI)
Maximum Frame Rate (UYVY)	3840 x 2160 @ 23 fps 2560 x 1440 @ 40 fps 1920 x 1080 @ 40 fps 1280 x 720 @ 40 fps 640 x 480 @ 52 fps
Maximum S/N Ratio	41.8 dB
HDR Support	Yes
Input Clock Range	48 MHz
Output Format	UYVY

Camera Interface

Module Data Transmission	MIPI CSI-2, up to 4 lanes
Communication Interface	I ² C
Connector	70 Pin Standardized Camera Connector

Power

Supply Voltage	I/O: 1.8V Analog: 2.8V Digital: 1.15V & 3.3V
Power Consumption	3840 x 2160 @ 23 fps \leq 1118 mW
Standby Power	\leq 54 mW Standby



Software Support

Platform Support	NXP i.MX8M Nano / Mini / Plus NXP i.MX93 TI Sitara™ AM62x / AM62A TI Jacinto™ TDA4VM / TDA4VA / TDA4VH NVIDIA Jetson Nano NVIDIA Xavier NX NVIDIA Orin Nano/NX
Operation Systems	Linux Yocto Android
SDK	VizionViewer™ SDK

Environmental and Mechanical

Dimensions	24.5(W) x 24.5(H) x 4.43(D) mm
Weight	\leq 3 grams
Operating Temperature	-30°C to +70°C

Certification and Compliance

Certification	Compliant with CE / FCC / RoHS / REACH directives
---------------	---

Spectral Characteristics

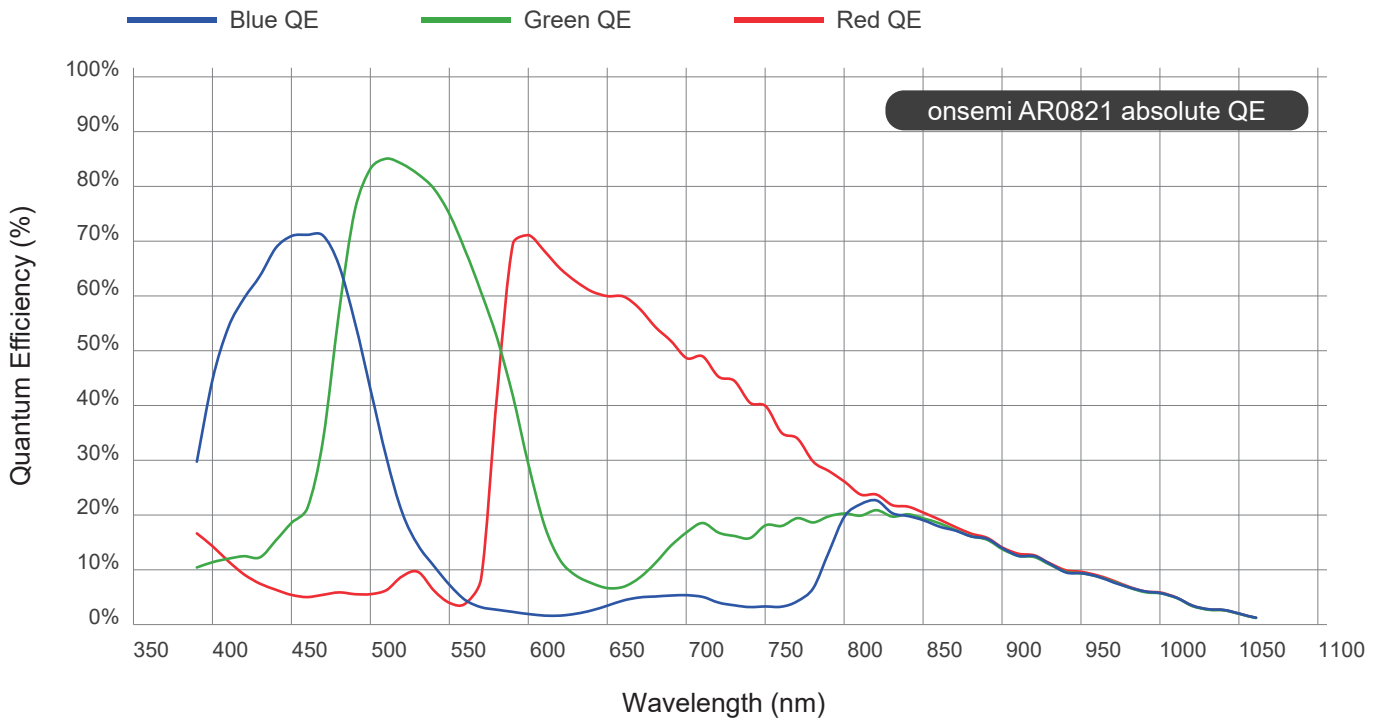

Block Diagram

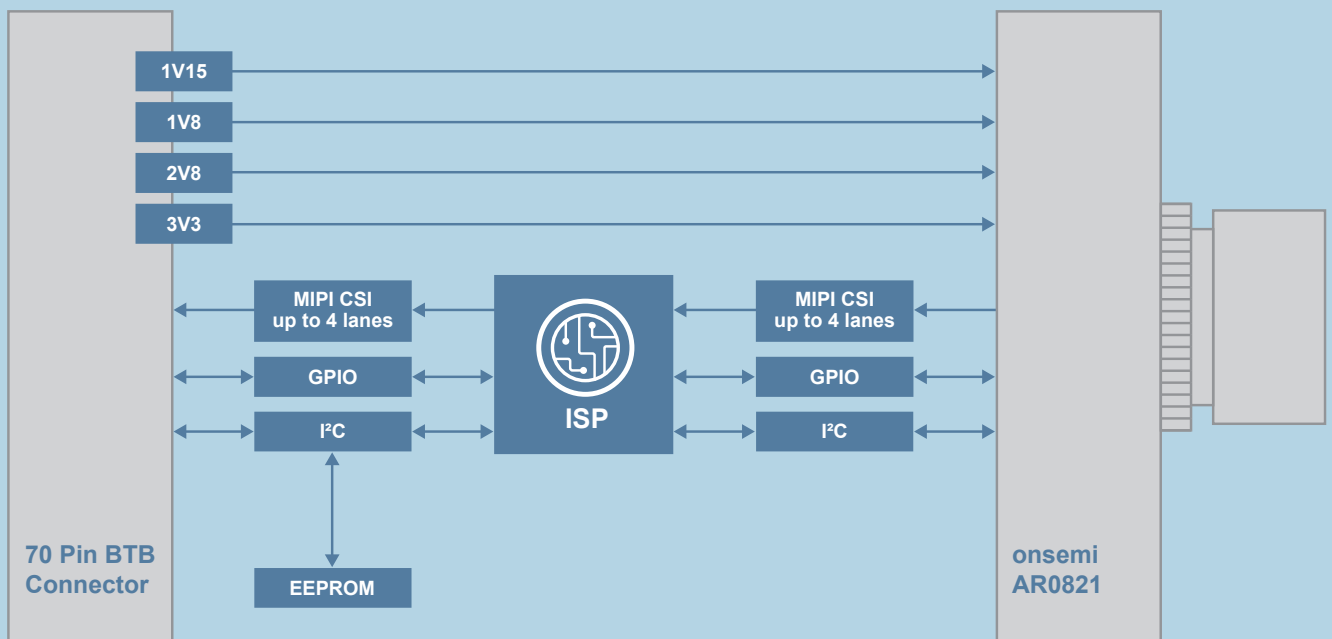

Dimensions (units in mm)

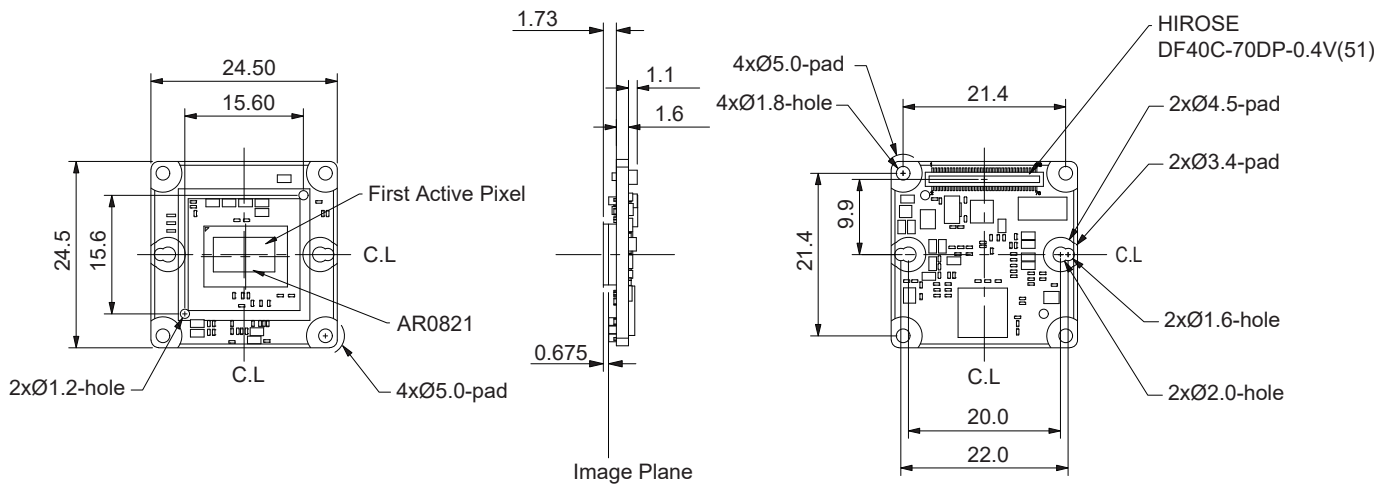

Switch Configuration

TechNexion EVK

Switch

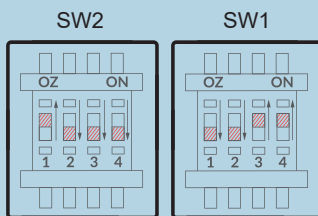

Power Sequence Setting

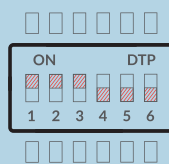

I²S

RPI Adapter

Switch

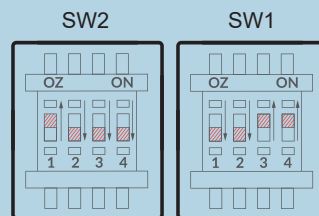

Power Sequence Setting

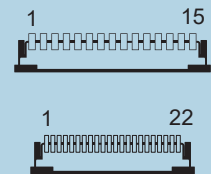

Connector Pin Definition

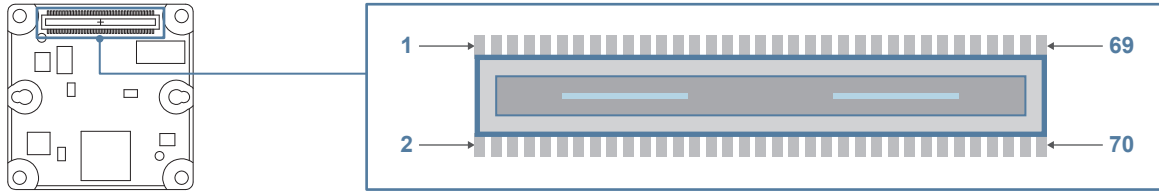

No.	Pin Define	Level	No.	Pin Define	Level
01	3V3D	3.3V	02	3V3D	3.3V
03	3V3D	3.3V	04	3V3D	3.3V
05	GND	GND	06	GND	GND
07	NC		08	NC	
09	GND	GND	10	GND	GND
11	2V8A	2.8V	12	2V8A	2.8V
13	GND	GND	14	GND	GND
15	1V8D	1.8V	16	1V8D	1.8V
17	GND	GND	18	GND	GND
19	1V15D	1.15V	20	1V15D	1.15V
21	GND	GND	22	GND	GND
23	NC		24	NC	
25	NC		26	NC	
27	NC		28	NC	
29	NC		30	NC	
31	NC		32	NC	
33	NC		34	NC	
35	GND	GND	36	GND	GND
37	H_CAM_DN0	1.8V	38	NC	
39	H_CAM_DP0	1.8V	40	CSI_nRST	1.8V
41	GND	GND	42	GND	GND
43	H_CAM_DN1	1.8V	44	STANDBY	1.8V
45	H_CAM_DP1	1.8V	46	NC	
47	GND	GND	48	GND	GND
49	H_CAM_DN2	1.8V	50	CAM_SHUTDOWN	1.8V
51	H_CAM_DP2	1.8V	52	NC	
53	GND	GND	54	GND	GND
55	H_CAM_DN3	1.8V	56	I ² C_SCL	1.8V
57	H_CAM_DP3	1.8V	58	I ² C_SDA	1.8V
59	GND	GND	60	GND	GND
61	H_CAM_CKN	1.8V	62	NC	
63	H_CAM_CKP	1.8V	64	NC	
65	GND	GND	66	NC	
67	NC		68	NC	
69	GND	GND	70	GND	GND

Lenses

Lens Information

Focus Type	Fixed Focus
Focal Length	6 mm
Aperture	F2.8
Lens D-FOV	72.0°
Lens H-FOV	61.0°
Lens V-FOV	47.0°
Module D-FOV	74.4° ± 5%
Module H-FOV	67.1° ± 5%
Module V-FOV	40.8° ± 5%
TTL	28.6 mm
BFL	8.8 mm
MOD	0.1 m
Distortion	<0.5%
IR-Filter	650 nm
Lens Operating Temperature	- 10°C to + 50°C

Order Information

TEVI-AR0821-x-Sxx-xx-xxx

Part Number Rules

Option	Code	Description
Chromaticity	C	Color
	M	Monochrome
Lens	-	-
	S74	S-Mount Module D-FOV 74°
Filter	-	-
	IR	IR Cut Filter 650nm
Evaluation Kit	-	70 pin Standardized Camera Connector
	EVK	70 pin Standardized Camera Connector with FPC cable
	RPI15	15 pin Standardized ZIF Connector with FFC cable
	RPI22	22 pin Standardized ZIF Connector with FFC cable
	NXP	Mini-SAS connection cable for NXP Evaluation Board

For customization, please contact your TechNexion sales representative.

TEVI-AR0821-x-Sxx-IR-EVK

onsemi AR0821 8MP rolling shutter with ISP camera module + S-Mount (M12) lens with IR-cut filter + FPC connection cable for TechNexion SOM EVK



Package Content

- TEVI-AR0821
- S-Mount lens
- 20cm flexible PCB for TechNexion EVK

TechNexion



TEVI-AR0821-x-Sxx-IR-RPI15

onsemi AR0821 8MP rolling shutter with ISP camera module + S-Mount (M12) lens with IR-cut filter + RPI 15 Pin converter and FFC

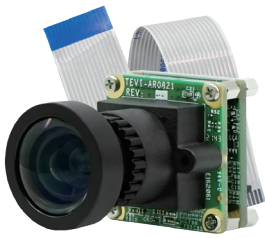

Package Content

- TEVI-AR0821
- S-Mount lens
- RPI 15 Pin compatible converter PCB
- 20cm 15 Pin FPC cable

TEXAS INSTRUMENTS

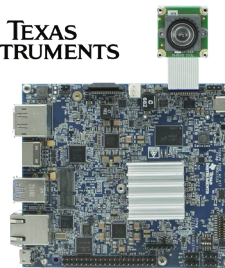

SK-TDA4VM

NVIDIA

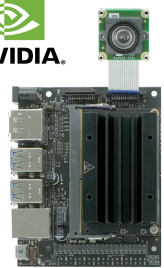

JETSON NANO XAVIER NX

TEVI-AR0821-x-Sxx-IR-RPI22

onsemi AR0821 8MP rolling shutter with ISP camera module + S-Mount (M12) lens with IR-cut filter + RPI 22 Pin converter and FFC

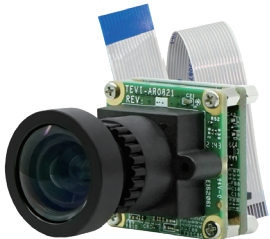

Package Content

- TEVI-AR0821
- S-Mount lens
- RPI 22 Pin compatible converter PCB
- 10cm 22 Pin FPC cable

NVIDIA

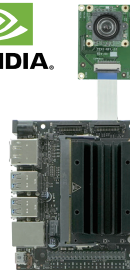

ORIN NANO ORIN NX

TEXAS INSTRUMENTS

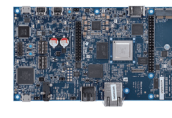

SK-AM62A

NXP

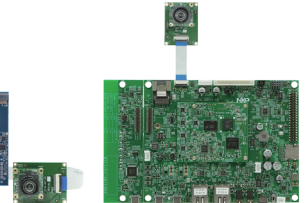

NXP i.MX93 EVK

TEVI-AR0821-x-Sxx-IR-NXP

onsemi AR0821 8MP rolling shutter with ISP camera module + S-Mount (M12) lens with IR-cut filter + Mini-SAS Connection Cable for NXP i.MX8 Evaluation Board

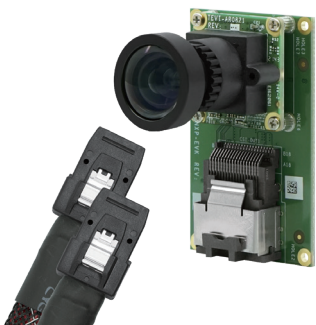

Package Content

- TEVI-AR0821
- S-Mount lens
- 20cm Mini-SAS cable for NXP i.MX8 Family EVK

NXP

- NXP i.MX8M NANO EVK**
- NXP i.MX8M MINI EVK**
- NXP i.MX8M PLUS EVK**

