



Expertise Applied | Answers Delivered

Power Supply Solutions (10 W to 1 kW+)



Mobile and wearable



Industrial



Consumer electronics



Appliances



Building automation

Users must independently evaluate the suitability of and test each product selected for their own specific applications. It is the User's sole responsibility to determine fitness for a particular system or use based on their own performance criteria, conditions, specific application, compatibility with other parts, and environmental conditions. Users must independently provide appropriate design and operating safeguards to minimize any risks associated with their applications and products. Littelfuse products are not designed for, and may not be used in, all applications. Read complete Disclaimer Notice at littelfuse.com/disclaimer-electronics.

Increasing efficiency requirements and increasing power needs are driving new generation of chargers

10 W

20 W

40 W

100 W

200 W

500 W

1 kW+

Power Levels



Typical applications



Littelfuse solutions

Fuse

TVS diode

Schottky diode

Digital temperature indicator



Typical applications



Littelfuse solutions

Fuse, PPTC

MOV, TVS diode

MOSFET

NTC

Acronyms:

TVS: transient voltage suppressor

MOV: metal oxide varistor



Typical applications

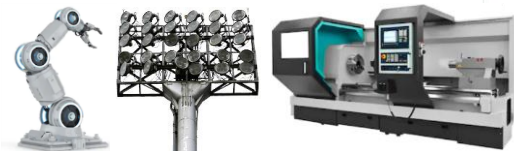

Littelfuse solutions

Fuse

MOV, TVS diode, GDT

MOSFET

Schottky diode

NTC: negative temperature co-efficient

GDT: gas discharge tube

Global power supply market is growing

Market trends and drivers

Power supply units convert an electrical source to the appropriate current, voltage, and frequency to power the required load

The increasing number of electrified and intelligent devices is driving growth in power supply volume

With the increased use of batteries for applications from battery wearable to power tools, the speed of charge transfer has led to the increase in power supply unit size

Improved power efficiency has led to reduced power supply unit size

Non-removable and enclosed batteries are driving the demand for wireless charging

Power supply unit sales are growing at a CAGR of 6%

Power Supply Unit Sales (2020–2027)

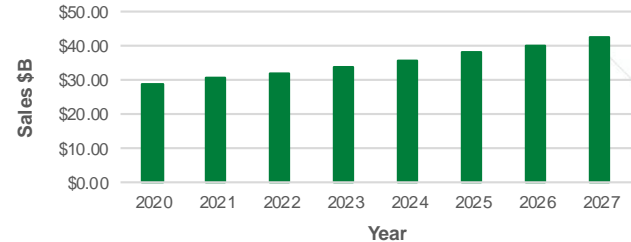

Power Supply Unit Sales by Applications (2020)

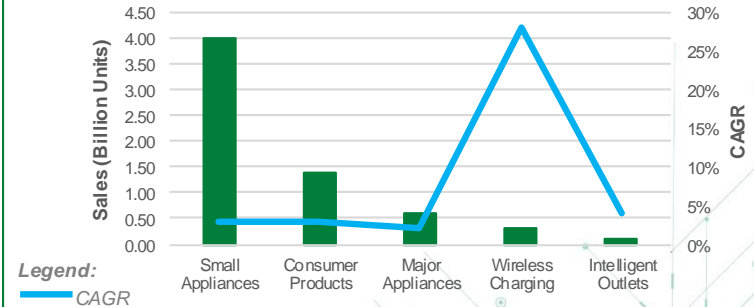

USB type-C power adapter

AC input primary protection

- Fuse



High-frequency converter and clamp

- TVS diode



Output protection, rectifier, and filter

- Schottky diode
- Digital temperature indicator

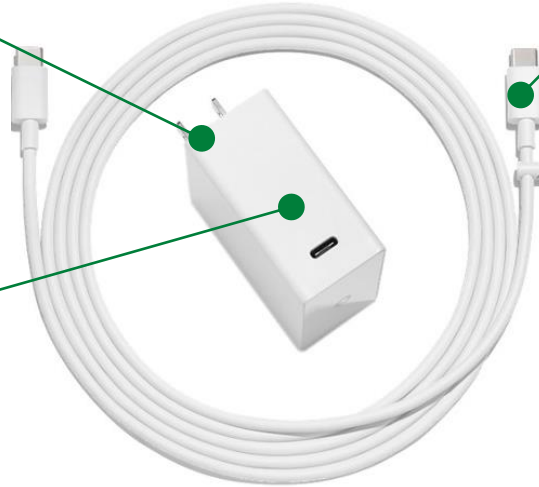

Component recommendations for USB type-C power adaptor

Click on the product series in the table below for more info

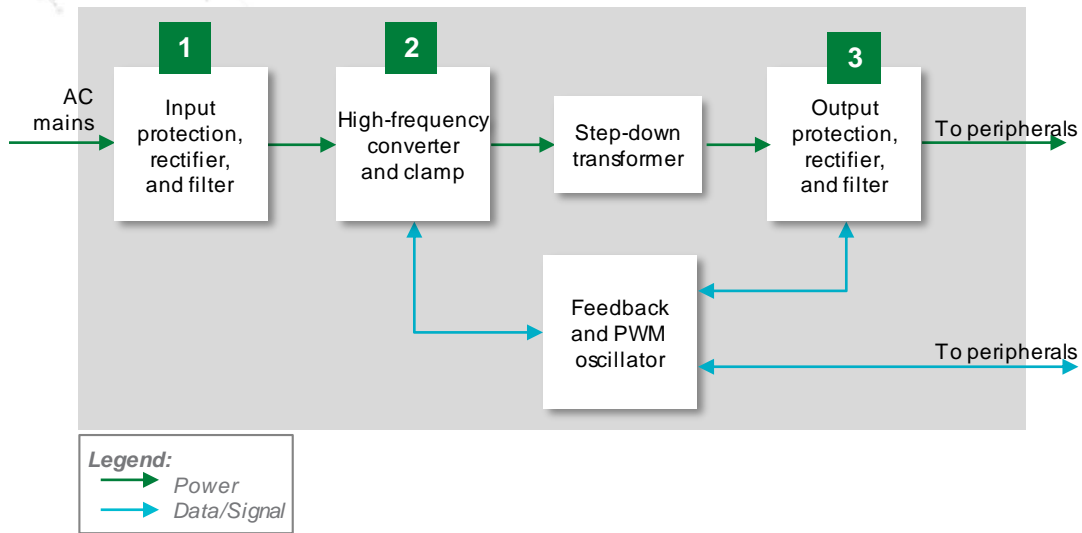

	Technology	Product series
1	Fuse	875 , 215 , 373 , 443E
2	TVS diode	P6KE , P6SMB , 8.0SMDJ , 1.5SMB , SMF4L
3	Schottky diode	MBR , DST
	setP™*	SETP0805-100-CC

* setP™ solution is recommended for USB type-C port protection.

USB type-C power adapter: Benefits and features of Littelfuse components



Click on the product series in the table below for more info

	Technology	Function in application	Product series	Benefits	Features
1	Fuse	Protects the power stage from overcurrent events	875 , 215 , 373 , 443E	Reduces customer qualification time by complying with regulatory safety standards, such as UL/IEC	Compliant with UL/IEC standards; low internal resistance; shock-safe; vibration resistant
2	TVS diode	Protects the power supply unit from voltage transients induced by lightning and voltage transient events	P6KE , P6SMB , 8.0SMDJ , 1.5SMB , SMF4L	Improves system reliability by protecting components from transients on power lines	600 W peak pulse capability; fast response time (<1 ps); compatible with the high reflow temperature profile (260 °C, 40 s)
3	Schottky diode	Provides rectification and blocking in power supply units	MBR , DST	Improves power supply unit efficiency	Low forward voltage drop; high-frequency operation; high junction temperature capability
	setP™	Provides an indication signal to help protect USB-C plugs and receptacles from overheating	SETP0805-100-CC	Helps improve reliability and user experience by reducing the risk of thermal damage; simple integration into existing USB-C systems	Fast response to thermal events; small form-factor; zero IR loss contribution; protects systems with a 100 W or higher power rating

Power supply in consumer electronics

AC input primary protection

- Fuse
- MOV
- NTC



Cable plug

- Digital temperature indicator



High-frequency converter and clamp

- MOSFET
- TVS diode



Secondary-side rectification

- Reverse blocking diode





Click on the product series in the table below for more info

Power supply block diagram

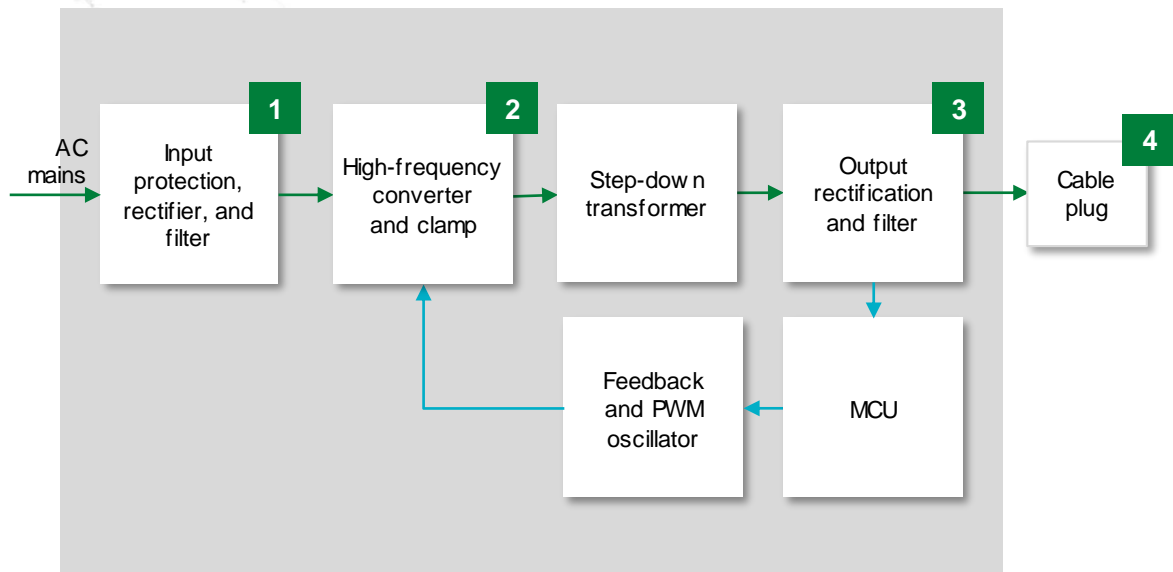

	Technology	Series
1	Fuse	875, 807, 373
	Inrush current limiter	ST
	MOV	C-III, TMOV
	GDT *	CG3
2	TVS diode	P6KE, P6SMB, 8.0SMDJ, 1.5SMB, SMF4L
	MOSFET	X2-class
3	Schottky barrier rectifier diode	MBR, DST
	PPTC	Low Rho
4	setP™ **	SETP0805-100-CC

* GDT in series with TMOV is recommended for connection between L – P.E. or N – P.E. to comply with the new IEC 62368-1 safety standards.

** setP™ solution is recommended for USB type-C port protection.

Legend:
 Power
 Data/Signal

Benefits of Littelfuse components in power supply units



Click on the product series in the table below for more info

	Technology	Function in application	Series	Benefits	Features
1	Fuse	Protects the power stage from overcurrent events	875 , 807 , 373	Reduces customer qualification time by complying with third-party safety standards such as UL/IEC	Compliance with third-party safety standards such as UL/IEC; low internal resistance; shock-safe; vibration resistant
	Inrush current limiter	Protects the power stage from high inrush current	ST	Protects downstream components such as smoothing capacitors from inrush current	Unique design enables them to handle extremely high current and voltage levels
	MOV	Protects the power supply unit from voltage transients and lightning	C-III , TMOV	Reduces customer qualification time by complying with third-party safety standards such as UL/IEC; protects end application from fire hazards	High energy absorption capability: 40–530 J (2 ms); integrated thermal protection avoids overheating caused during abnormal voltage events resulting in high surge currents
	GDT	Connected in series with TMOV to protect the power supply unit from voltage transients and lightning	CG3	Enables product to comply with the new IEC 62368-1 standard; small form-factor allows for compact system design	High energy absorption capability; small form-factor; low leakage current
2	TVS diode	Protects the power supply unit from voltage transients	P6KE , P6SMB , 8.0SMDJ , 1.5SMB , SMF4L	Improves system reliability by protecting downstream components from transients on power lines	600 W peak pulse capability; glass passivated chip junction; compatible with lead-free solder reflow temperature profile
	MOSFET	High switching speed in power supply units	X2-class	Fast response time and low heat signature	Low $R_{ds(on)}$; dv/dt ruggedness
3	Schottky barrier rectifier diode	Rectification and blocking in power supply units	MBR , DST	Enables the design of high efficiency power supplies	Ultra-low forward voltage drop; high-frequency operation
	PPTC	Provides overcurrent protection	Low Rho	Less power dissipation; compact design	Ultra-low internal resistance; very thin profile
4	setP™	Provides an indication signal to help protect USB-C plugs and receptacles from over-heating	SETP0805-100-CC	Helps improve reliability and user experience by reducing the risk of thermal damage; simple integration into existing USB-C systems	Fast response to thermal events; small form-factor; zero IR loss contribution; protects systems with a 100 W or higher power rating

Functional elements in Lithium-ion battery charger

AC input primary protection



- Fuse
- MOV
- NTC

High-frequency converter and clamp



- MOSFET
- TVS diode

Secondary side rectification



- Reverse blocking diode

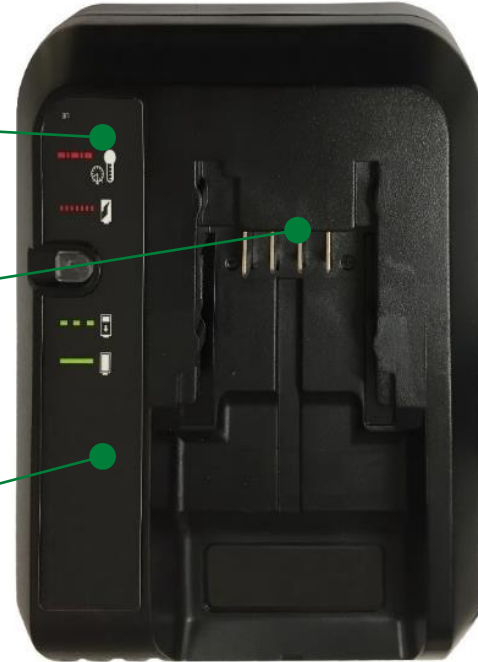

Lithium-ion battery charger block diagram

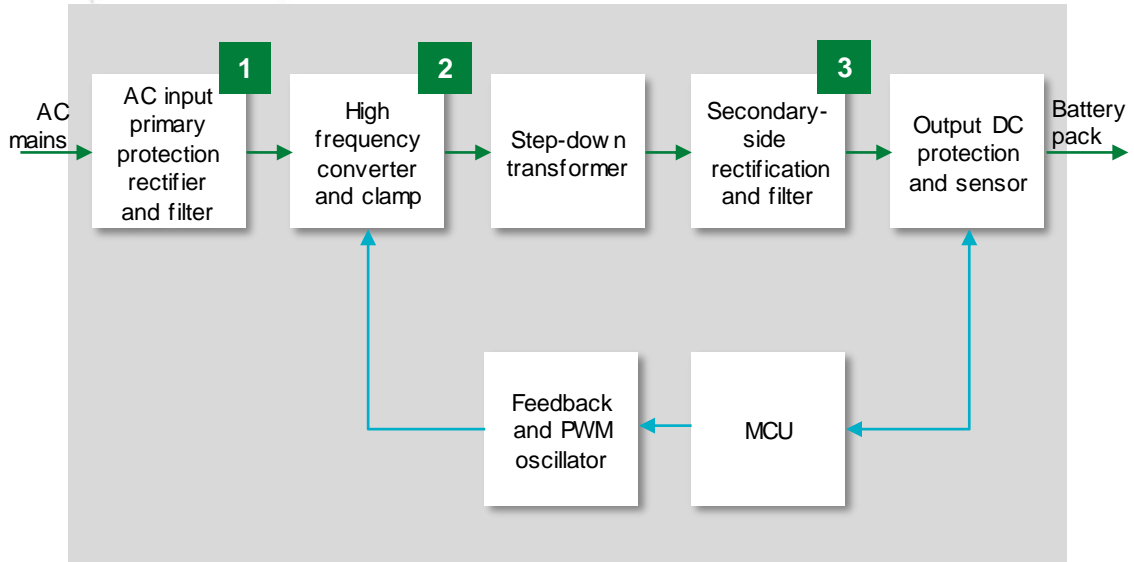

Legend:
 Power
 Data/Signal

	Technology	Series
1	Fuse	5X20mm Fuse , TR , TE
	NTC *	ST
	MOV	LA , C-III , TMOV
2	MOSFET	X2-class
	TVS diode	P6KE , P6SMB , 8_0SMDJ , 1.5SMB , SMF4L
3	Schottky diode	MBR , DST

* Thermally coupled to Li-Ion cells.
Acronyms:
 NTC: negative temperature co-efficient
 MOV: metal oxide varistor
 TVS: transient voltage suppressor

Potential Littelfuse products for Li-ion battery charger

	Technology	Function in application	Series	Benefits	Features
1	Fuse	Protects the power stage from overcurrent events	5X20mm Fuse , TR , IE	Reduces customer qualification time by complying with third party safety standards such as UL/IEC	Compliance with third-party safety standards such as UL/IEC; low internal resistance; shock-safe; vibration resistant
	NTC	Protects the power stage from high inrush current	ST	Improves system reliability	Small form factor, fast thermal response
	MOV	Protects the power supply unit from voltage surges such as lightning, transients	LA , C-III , TMOV	Reduces customer qualification time by complying with third-party safety standards such as UL/IEC	High energy absorption capability: 40–530 J (2 ms)
2	MOSFET	High switching speed in power supply units	X2-class	Fast response time and lower heat signature	Low $R_{ds(on)}$, dv/dt ruggedness
	TVS diode	Protects power unit from voltage transients	P6KE , P6SMB , 8.0SMDJ , 1.5SMB , SMF4L	Improves system reliability by protecting downstream components from transients on power lines	Excellent clamping capability
3	Schottky diode	Rectification and blocking in power supply units	MBR , DST	Enables the design of high efficiency power supplies	Ultra-low forward voltage drop, high frequency operation

Industrial power supply

AC Input



- Fuse
- MOV
- NTC

Output rectifier and filter



- Hybrid voltage suppression

High frequency converter and clamp



- MOSFET
- Rectifier diodes

DC Output protection



- Diode array
- Resettable PPTC

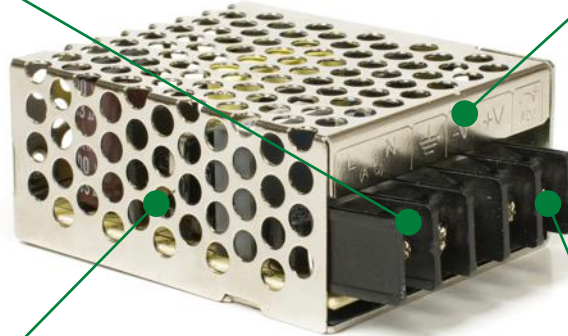

Industrial power supply block diagram (Fly-back topology)

Click on the product series in the table below for more info

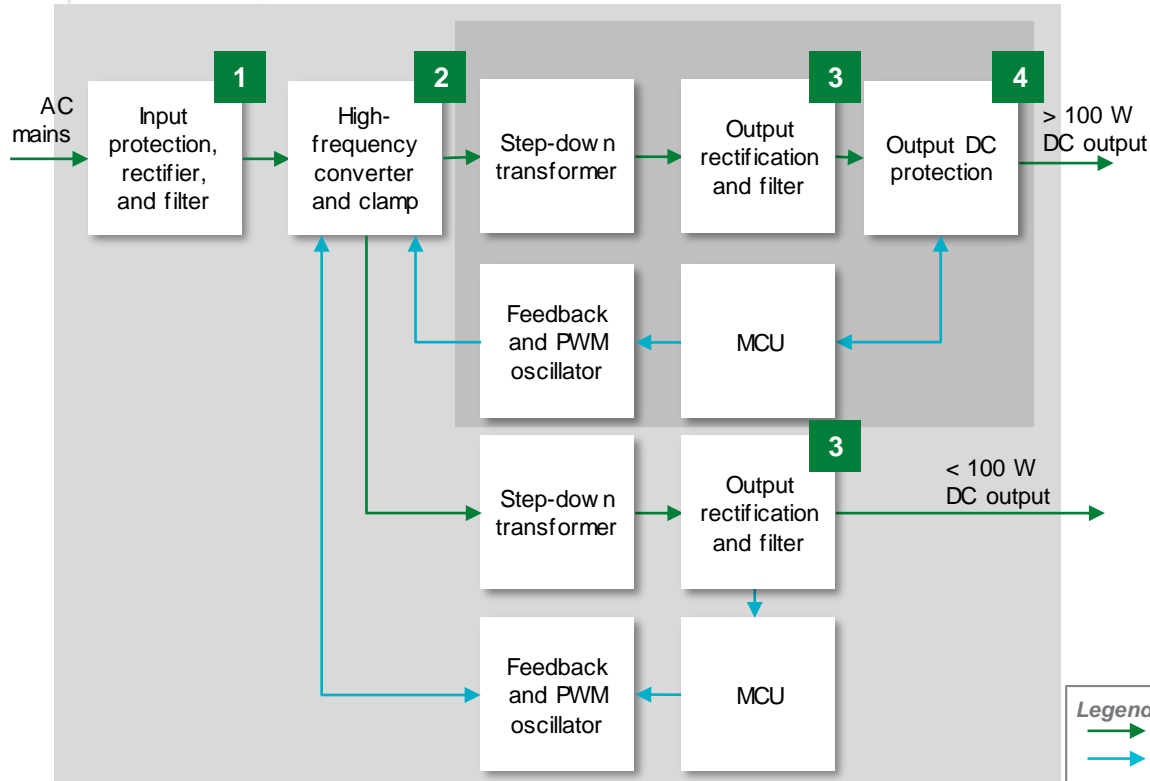

	Technology	Series
1	Fuse	875, 215, 373
	Inrush current limiter	ST
	MOV	C-III, TMOV
	GDT *	CG3
	SIDACtor™ + MOV	P2300 + V300LA20AP
2	TVS diode	P6KE, P6SMB, 8.0SMDJ, 1.5SMB, SMF4L
	MOSFET	X2-class
3	Schottky barrier rectifier diode	MBR, DST
4	Fuse	253, 276

* GDT is recommended to be connected in series with TMOV to comply with the new IEC 62368-1 safety standards.

Benefits of Littelfuse products for industrial power supply

 Click on the product series in the table below for more info

	Technology	Function in application	Series	Benefits	Features
1	Fuse	Protects the power stage from overcurrent events	875 , 215 , 373	Reduces customer qualification time by complying with third-party safety standards such as UL/IEC	Compliance with third-party safety standards such as UL/IEC; low internal resistance; shock-safe; vibration resistant
	Inrush current limiter	Protects the power stage from high inrush current	ST	Protects downstream components such as smoothing capacitors from inrush current	Unique design enables them to handle extremely high current and voltage levels
	MOV	Protects the power supply unit from voltage transients induced by lightning	C-III , TMOV	Reduces customer qualification time by complying with third-party safety standards such as UL/IEC; protects end application from fire hazards	High energy absorption capability: 40–530 J (2 ms); integrated thermal protection avoids over-heating caused during abnormal voltage events, resulting in high surge currents
	GDT	Connected in series with TMOV to protect the power supply unit from voltage transients and lightning	CG3	Enables product to comply with the new IEC 62368-1 standard; small form-factor allows for compact system design	High energy absorption capability; small form-factor; low leakage current
	SIDACTor™ + MOV	Protects the power supply unit from voltage transients induced by lightning	P2300 + V300LA20AP	Enables safe operation in areas exposed to repeated lightning surges	High energy absorption capability; low clamping voltage; low leakage current
2	TVS diode	Protects the power supply unit from voltage transients	P6KE , P6SMB , 8.0SMDJ , 1.5SMB , SMF4L	Improves system reliability by protecting downstream components from transients on power lines	600 W peak pulse capability; glass passivated chip junction; compatible with lead-free solder reflow temperature profile
	MOSFET	High switching speed in power supply units	X2-class	Fast response time and low heat signature	Low Rds(on); dv/dt ruggedness
3	Schottky barrier rectifier diode	Rectification and blocking in power supply units	MBR , DST	Enables the design of high-efficiency power supply units	Ultra-low forward voltage drop; high-frequency operation
4	Fuse	Protects the power stage from overcurrent events	253 , 276	Reduces customer qualification time by complying with third-party safety standards such as UL/IEC	Very fast-acting; small form factor; wide current rating range

Compliance and standards for power supply units

Standard	Title	General scope	Littelfuse technology	Region
UL 1310	Standard for Class 2 Power Units	Can be used in lieu of IEC/UL 62368-1	PPTC, Fuses	North America
IEC 60950-1	Information Technology Equipment Safety	Applicable to mains-powered or battery-powered information technology equipment, with rated voltage not exceeding 600 V	Fuse, MOV, GDT, SIDACTor™	Global
IEC 62368-1	Audio/Video, Information, and Communication Technology Equipment — Part 1: Safety Requirements	Safety of equipment within the field of audio, video, information, and communication technology (rated voltage not exceeding 600 V)	Fuse, MOV, GDT, SIDACTor™	Global
IEC 61000-4-2	Electrostatic Discharges	Checks the capability of the equipment to survive repetitive electrical fast transients and bursts	TVS diode, PESD	Global
IEC 61000-4-4	Fast Transient Burst Test	Evaluates the immunity of the equipment when subjected to electrical fast transient/bursts on supply, signal, control, and earth ports	TVS diode, MLV, GDT, MOV	Global
IEC 61000-4-5	Fast Transient Surge Test	Evaluates the immunity of the equipment when subjected to surges	TVS diode	Global

Additional information can be found on [Littelfuse.com](https://www.littelfuse.com)

Circuit Protection Selection Guide



Sensor Selection Guide



Power Semiconductor Selection Guide



Click on the image to open the catalog

setP™ Flyer



setP™ Design Guide



Local resources supporting our global customers

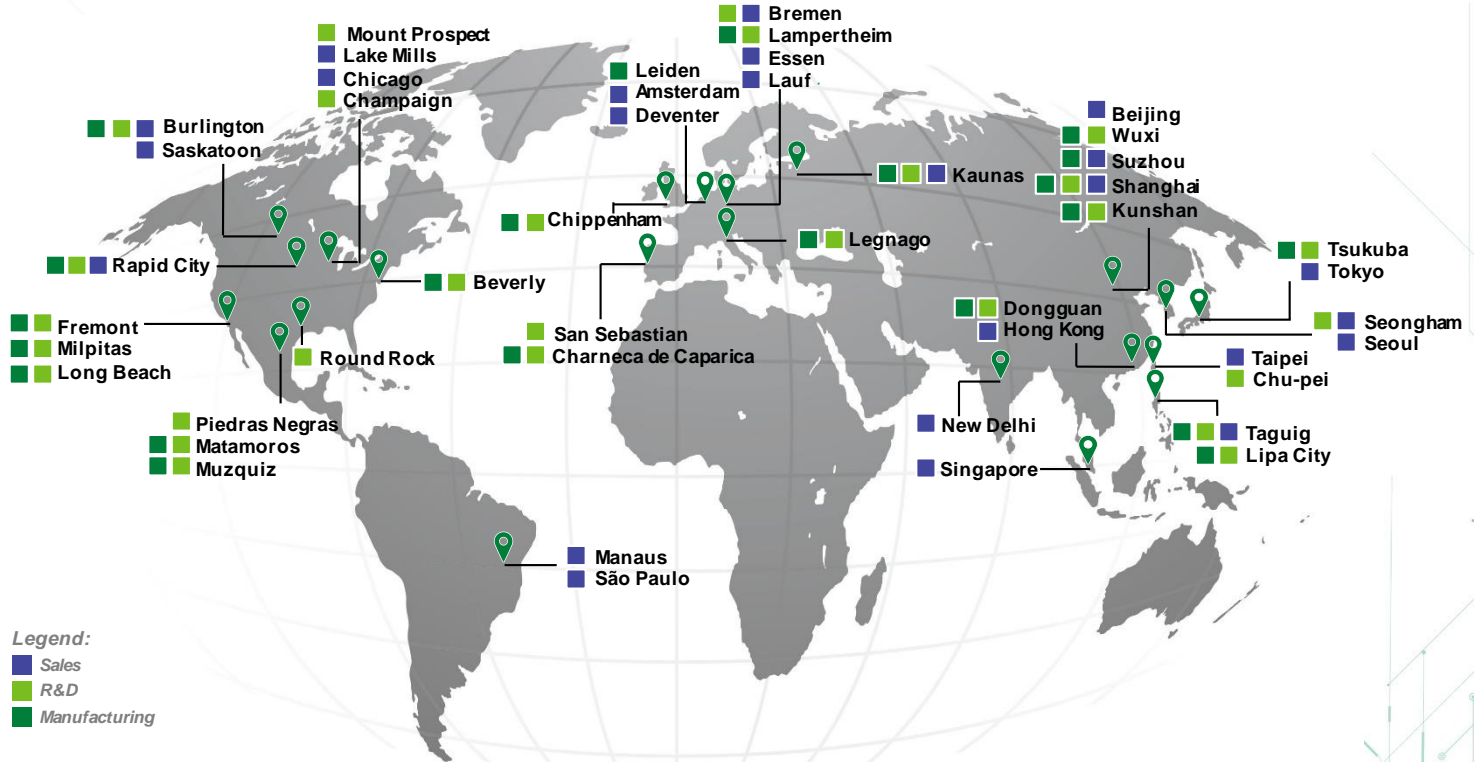

Partner for tomorrow's electronic systems

Broad product portfolio

A global leader with a broad product portfolio, covering every aspect of protection, sensing, and control

Application expertise

Our engineers directly partner with customers to help speed up product design and meet their unique needs

Global customer service

Our global customer service team is with you to anticipate your needs and ensure a seamless experience

Compliance & regulatory expertise

We help customers in the design process to account for requirements set by global regulatory authorities

Testing capabilities

To help customers get products to the market faster, we offer certification testing to global regulatory standards

Global manufacturing

High-volume manufacturing that is committed to the highest quality standards



This document is provided by Littelfuse, Inc. ("Littelfuse") for informational and guideline purposes only. Littelfuse assumes no liability for errors or omissions in this document or for any of the information contained herein. Information is provided on an "as is" and "with all faults" basis for evaluation purposes only. Applications described are for illustrative purposes only, and Littelfuse makes no representation that such applications will be suitable for the customer's specific use without further testing or modification. Littelfuse expressly disdains all warranties, whether express, implied, or statutory, including but not limited to the implied warranties of merchantability and fitness for a particular purpose, and non-infringement. It is the customer's sole responsibility to determine suitability for a particular system or use based on their own performance criteria, conditions, specific application, compatibility with other parts, and environmental conditions. Customers must independently provide appropriate design and operating safeguards to minimize any risks associated with their applications and products. Read complete Disclaimer Notice at [littelfuse.com/disclaimer-electronics](https://www.littelfuse.com/disclaimer-electronics).



[Littelfuse.com](https://www.littelfuse.com)