

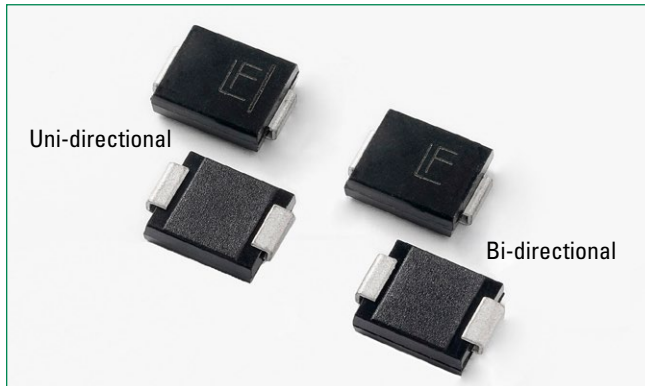

5.0SMDJ Series



Agency Approvals

Agency	Agency File Number
	E230531

Maximum Ratings and Thermal Characteristics (T_A=25°C unless otherwise noted)

Parameter	Symbol	Value	Unit
Peak Pulse Power Dissipation at T _L =25°C by 10/1000µs Waveform (Fig.2)(Note 1), (Note 2)	P _{PPM}	5000	W
Power Dissipation on Infinite Heat Sink at T _L =50°C	P _D	6.5	W
Peak Forward Surge Current, 8.3ms Single Half Sine Wave (Note 3)	I _{FSM}	300	A
Maximum Instantaneous Forward Voltage at 100A for Unidirectional Only	V _F	5.0	V
Operating Temperature Range	T _J	-65 to 150	°C
Storage Temperature Range	T _{STG}	-65 to 175	°C
Typical Thermal Resistance Junction to Lead	R _{θJL}	15	°C/W
Typical Thermal Resistance Junction to Ambient	R _{θJA}	75	°C/W

Notes:

1. Non-repetitive current pulse, per Fig. 4 and derated above T_J (initial) =25°C per Fig. 3.
2. Mounted on copper pad area of 0.31x0.31" (8.0 x 8.0mm) to each terminal.
3. Measured on 8.3ms single half sine wave or equivalent square wave for unidirectional component only, duty cycle = 4 per minute maximum.

Functional Diagram

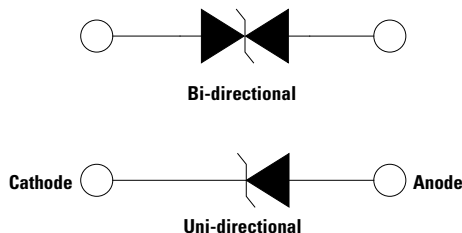

Description

The 5.0SMDJ series is designed specifically to protect sensitive electronic equipment from voltage transients induced by lightning and other transient voltage events.

Features

- 5000W peak pulse power capability at 10/1000µs waveform, repetition rate (duty cycles):0.01%
- SMD low profile surface mount package minimizing PCB footprint
- Typical failure mode is short from over-specified voltage or current
- Whisker test is conducted based on JEDEC JESD201A per its table 4a and 4c
- IEC 61000-4-2 ESD 30kV(Air), 30kV (Contact)
- ESD protection of data lines in accordance with IEC 61000-4-2
- EFT protection of data lines in accordance with IEC 61000-4-4
- Built-in strain relief
- Glass passivated chip junction
- Fast response time: typically less than 1.0ps from 0V to BV min
- Excellent clamping capability
- Low incremental surge resistance
- Typical I_R less than 5µA when V_{BR} min>22V
- High temperature to reflow soldering guaranteed: 260°C/40sec
- V_{BR} @ T_J = V_{BR} @ 25°C x (1 + α T x (T_J - 25)) (α T: Temperature Coefficient,)
- UL Recognized compound meeting flammability rating V-0
- Meet MSL level1, per J-STD-020, LF maximum peak of 260°C
- Matte tin lead-free plated
- Halogen free and RoHS compliant
- Pb-free E3 means 2nd level interconnect is Pb-free and the terminal finish material is tin(Sn) (IPC/JEDEC J-STD-609A.01)
- Recognized to UL 497B as an Isolated Loop Circuit Protector

Applications

TVS devices are ideal for the protection of I/O Interfaces, V_{CC} bus and other vulnerable circuits used in Telecom, Computer, Industrial and Consumer electronic applications.

Additional Information



Datasheet



Resources



Samples

Electrical Characteristics (T_A=25°C unless otherwise noted)

Part Number (Uni)	Part Number (Bi)	Marking		Reverse Stand off Voltage V _R (Volts)	Breakdown Voltage V _{BR} (Volts) @ I _T		Test Current I _T (mA)	Maximum Clamping Voltage V _C @I _{pp} (10/1000µs) (V)	Maximum Peak Pulse Current I _{pp} (10/1000µs) (A)	Maximum Clamping Voltage V _C @I _{pp} (8/20µs) (V)	Maximum Peak Pulse Current I _{pp} (8/20µs) (A)	Maximum Reverse Leakage I _R @V _R (µA)	Maximum Temperature Coefficient of V _{BR} (%/C)	Agency Approval 
		Uni	Bi		Min.	Max.								
5.0SMDJ12A	5.0SMDJ12CA	5PEP	5BEP	12.0	13.3	14.7	10	19.9	252.0	25.7	1890.0	800	0.075	X
5.0SMDJ13A	5.0SMDJ13CA	5PEQ	5BEQ	13.0	14.4	15.9	10	21.5	233.0	27.8	1747.5	500	0.076	X
5.0SMDJ14A	5.0SMDJ14CA	5PER	5BER	14.0	15.6	17.2	10	23.2	216.0	30.0	1620.0	200	0.08	X
5.0SMDJ15A	5.0SMDJ15CA	5PES	5BES	15.0	16.7	18.5	1	24.4	205.0	31.5	1537.5	100	0.083	X
5.0SMDJ16A	5.0SMDJ16CA	5PET	5BET	16.0	17.8	19.7	1	26.0	193.0	33.6	1447.5	50	0.084	X
5.0SMDJ17A	5.0SMDJ17CA	5PEU	5BEU	17.0	18.9	20.9	1	27.6	181.0	35.7	1357.5	20	0.085	X
5.0SMDJ18A	5.0SMDJ18CA	5PEV	5BEV	18.0	20.0	22.1	1	29.2	172.0	37.7	1290.0	10	0.088	X
5.0SMDJ20A	5.0SMDJ20CA	5PEW	5BEW	20.0	22.2	24.5	1	32.4	155.0	41.9	850.0	5	0.091	X
5.0SMDJ22A	5.0SMDJ22CA	5PEX	5BEX	22.0	24.4	26.9	1	35.5	141.0	45.9	1057.5	5	0.092	X
5.0SMDJ24A	5.0SMDJ24CA	5PEZ	5BEZ	24.0	26.7	29.5	1	38.9	129.0	50.3	967.5	5	0.092	X
5.0SMDJ26A	5.0SMDJ26CA	5PFE	5BFE	26.0	28.9	31.9	1	42.1	119.0	54.4	892.5	5	0.093	X
5.0SMDJ28A	5.0SMDJ28CA	5PFG	5BFG	28.0	31.1	34.4	1	45.4	110.0	58.7	825.0	5	0.094	X
5.0SMDJ30A	5.0SMDJ30CA	5PFK	5BFK	30.0	33.3	36.8	1	48.4	103.0	62.5	772.5	5	0.096	X
5.0SMDJ33A	5.0SMDJ33CA	5PFM	5BFM	33.0	36.7	40.6	1	53.3	93.9	68.9	704.3	5	0.097	X
5.0SMDJ36A	5.0SMDJ36CA	5PFP	5BFP	36.0	40.0	44.2	1	58.1	86.1	75.1	645.8	5	0.098	X
5.0SMDJ40A	5.0SMDJ40CA	5PFR	5BFR	40.0	44.4	49.1	1	64.5	77.6	83.3	582.0	5	0.099	X
5.0SMDJ43A	5.0SMDJ43CA	5PFT	5BFT	43.0	47.8	52.8	1	69.4	72.1	89.7	540.8	5	0.1	X
5.0SMDJ45A	5.0SMDJ45CA	5PFV	5BFV	45.0	50.0	55.3	1	72.7	68.8	93.9	516.0	5	0.101	X
5.0SMDJ48A	5.0SMDJ48CA	5PFX	5BFX	48.0	53.3	58.9	1	77.4	64.7	100.0	485.3	5	0.101	X
5.0SMDJ51A	5.0SMDJ51CA	5PFZ	5BFZ	51.0	56.7	62.7	1	82.4	60.7	106.5	455.3	5	0.101	X
5.0SMDJ54A	5.0SMDJ54CA	5PGE	5BGE	54.0	60.0	66.3	1	87.1	57.5	112.5	431.3	5	0.102	X
5.0SMDJ58A	5.0SMDJ58CA	5PGG	5BGG	58.0	64.4	71.2	1	93.6	53.5	120.9	401.3	5	0.103	X
5.0SMDJ60A	5.0SMDJ60CA	5PGK	5BGK	60.0	66.7	73.7	1	96.8	51.7	125.1	387.8	5	0.103	X
5.0SMDJ64A	5.0SMDJ64CA	5PGM	5BGM	64.0	71.1	78.6	1	103.0	48.6	133.1	364.5	5	0.104	X
5.0SMDJ70A	5.0SMDJ70CA	5PGP	5BGP	70.0	77.8	86.0	1	113.0	44.3	146.0	332.3	5	0.105	X
5.0SMDJ75A	5.0SMDJ75CA	5PGR	5BGR	75.0	83.3	92.1	1	121.0	41.4	156.3	310.5	5	0.106	X
5.0SMDJ78A	5.0SMDJ78CA	5PGT	5BGT	78.0	86.7	95.8	1	126.0	39.7	162.8	297.8	5	0.106	X
5.0SMDJ85A	5.0SMDJ85CA	5PGV	5BGV	85.0	94.4	104.0	1	137.0	36.5	177.0	273.8	5	0.106	X
5.0SMDJ90A	5.0SMDJ90CA	5PGX	5BGX	90.0	100.0	111.0	1	146.0	34.3	188.6	257.3	5	0.107	X
5.0SMDJ100A	5.0SMDJ100CA	5PGZ	5BGZ	100.0	111.0	123.0	1	162.0	30.9	209.3	231.8	5	0.107	X
5.0SMDJ110A	5.0SMDJ110CA	5PHE	5BHE	110.0	122.0	135.0	1	177.0	28.3	228.7	212.3	5	0.107	X
5.0SMDJ120A	5.0SMDJ120CA	5PHG	5BHG	120.0	133.0	147.0	1	193.0	26.0	249.4	195.0	5	0.108	X
5.0SMDJ130A	5.0SMDJ130CA	5PHK	5BHK	130.0	144.0	159.0	1	209.0	24.0	270.0	180.0	5	0.108	X
5.0SMDJ140A	5.0SMDJ140CA	5PHL	5BHL	140.0	156.0	172.0	1	226.1	22.2	292.1	166.5	5	0.108	X
5.0SMDJ150A	5.0SMDJ150CA	5PHM	5BHM	150.0	167.0	185.0	1	243.0	20.6	314.0	154.5	5	0.108	X
5.0SMDJ160A	5.0SMDJ160CA	5PHP	5BHB	160.0	178.0	197.0	1	259.0	19.3	334.6	144.8	5	0.108	X
5.0SMDJ170A	5.0SMDJ170CA	5PHR	5BHR	170.0	189.0	209.0	1	275.0	18.2	355.3	136.5	5	0.108	X

For bidirectional type having V_R of 20 volts and less, the I_T limit is double.

For parts without A, the V_{BR} is ± 10% and V_C is 5% higher than with A parts, the parts without A are currently available, but not recommended for new designs. The parts with A are preferred.

I-V Curve Characteristics

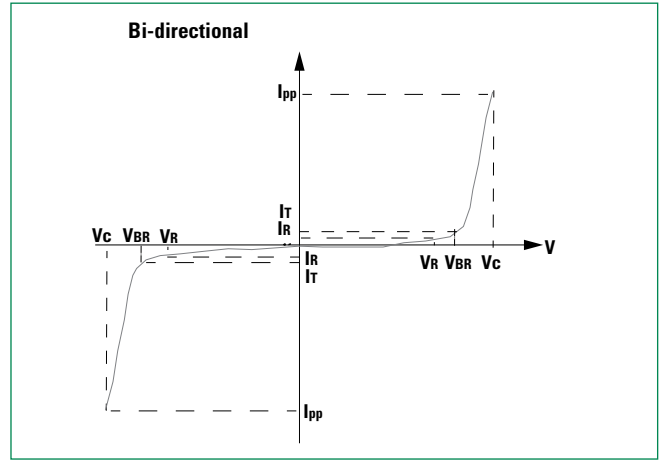
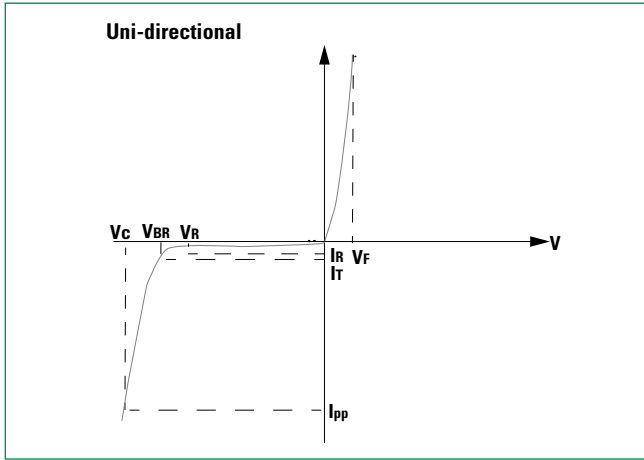

- P_{PPM}** Peak Pulse Power Dissipation – Max power dissipation
- V_R** Stand-off Voltage – Maximum voltage that can be applied to the TVS without operation
- V_{BR}** Breakdown Voltage – Maximum voltage that flows through the TVS at a specified test current (I_t)
- V_C** Clamping Voltage – Peak voltage measured across the TVS at a specified I_{ppm} (peak impulse current)
- I_R** Reverse Leakage Current – Current measured at V_R
- V_F** Forward Voltage Drop for Uni-directional

Ratings and Characteristic Curves ($T_A=25^\circ\text{C}$ unless otherwise noted)

Figure 1 - TVS Transients Clamping Waveform

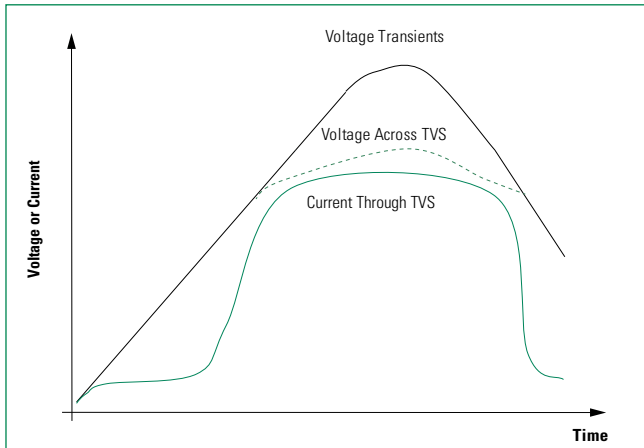
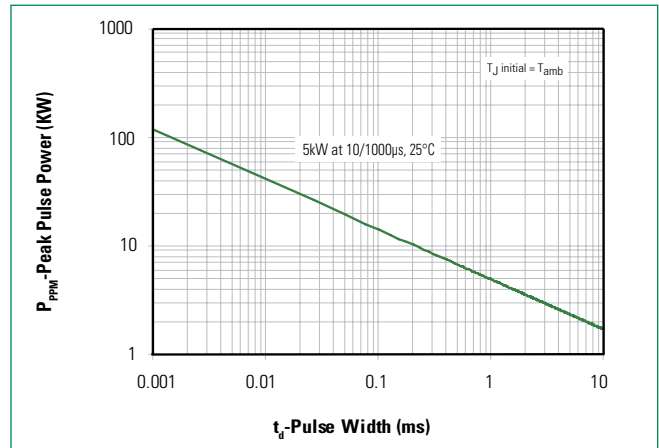

Figure 2 - Peak Pulse Power Rating



Ratings and Characteristic Curves ($T_A=25^{\circ}\text{C}$ unless otherwise noted) (Continued)

Figure 3 - Peak Pulse Power Derating Curve

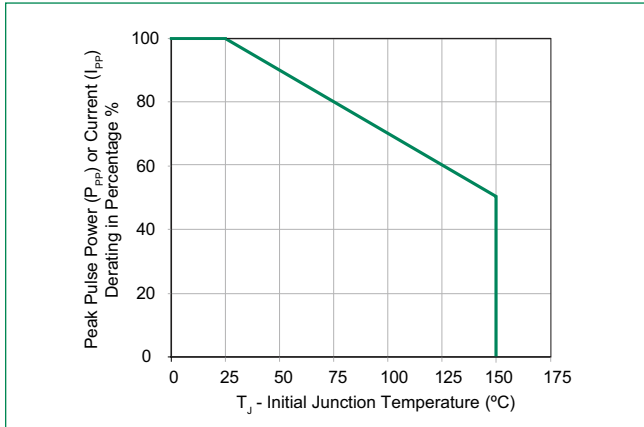

Figure 4 - Pulse Waveform

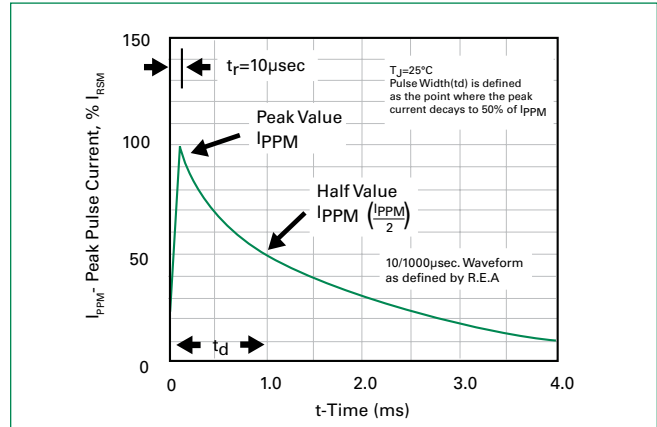

Figure 5 - Typical Junction Capacitance

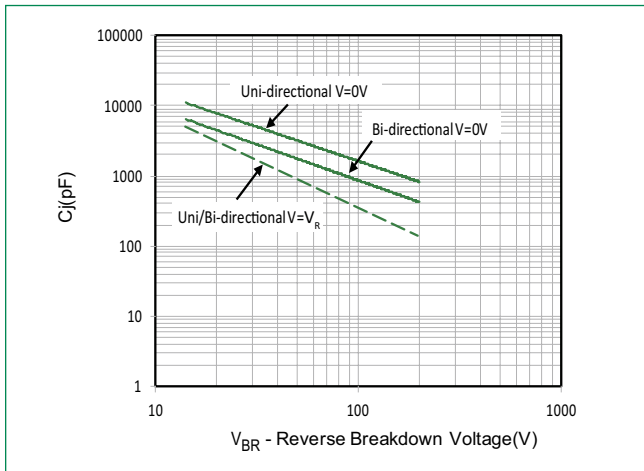

Figure 6 - Typical Transient Thermal Impedance

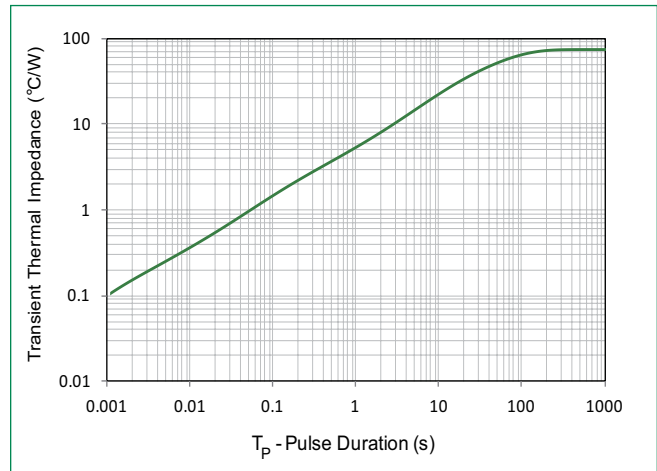

Figure 7 - Maximum Non-Repetitive Peak Forward Surge Current Uni-Directional Only

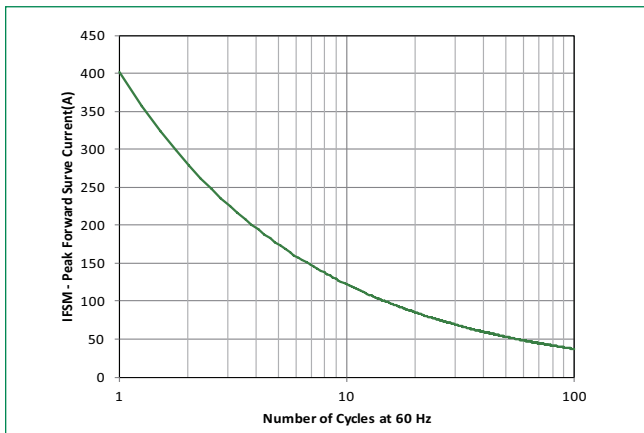
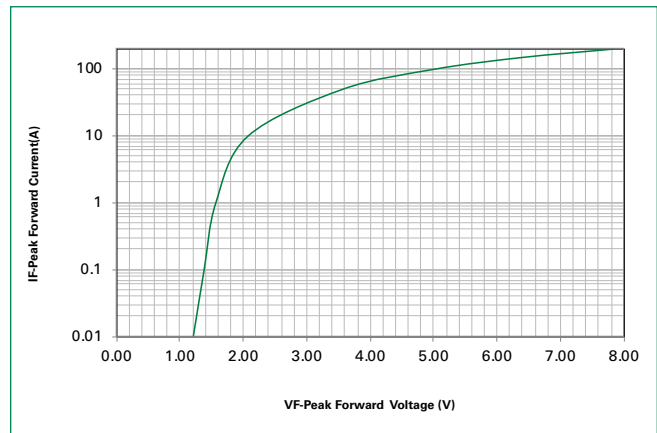
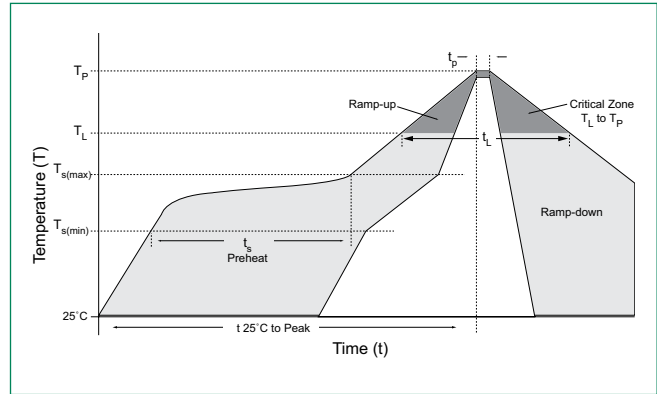

Figure 8 - Peak Forward Voltage Drop vs Peak Forward Current (Typical Values)



Soldering Parameters

Reflow Condition		Lead-free assembly
Pre Heat	- Temperature Min ($T_{s(min)}$)	150°C
	- Temperature Max ($T_{s(max)}$)	200°C
	- Time (min to max) (t_s)	60 – 180 secs
Average ramp up rate (Liquidus Temp (T_A) to peak		3°C/second max
$T_{s(max)}$ to T_A - Ramp-up Rate		3°C/second max
Reflow	- Temperature (T_L) (Liquidus)	217°C
	- Time (min to max) (t_L)	60 – 150 seconds
Peak Temperature (T_p)		260 ^{+0/-5} °C
Time within 5°C of actual peak Temperature (t_p)		20 – 40 seconds
Ramp-down Rate		6°C/second max
Time 25°C to peak Temperature (T_p)		8 minutes Max.
Do not exceed		280°C



Physical Specifications

Weight	0.007 ounce, 0.21 grams
Case	JEDEC DO214AB. Molded component over glass passivated junction
Polarity	Color band denotes positive end (cathode) except Bidirectional.
Terminal	Matte Tin-plated leads, Solderable per JESD22-B102

Environmental Specifications

High Temp. Storage	JESD22-A103
HTRB	JESD22-A108
Temperature Cycling	JESD22-A104
MSL	JEDEC-J-STD-020, Level 1
H3TRB	JESD22-A101
RSH	JESD22-A111

Dimensions

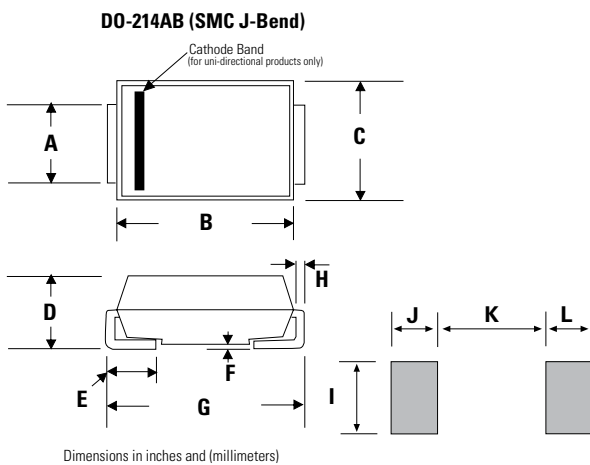

Dimensions	Inches		Millimeters	
	Min	Max	Min	Max
A	0.114	0.126	2.900	3.200
B	0.260	0.280	6.600	7.110
C	0.220	0.245	5.590	6.220
D	0.079	0.103	2.060	2.620
E	0.030	0.060	0.760	1.520
F	-	0.008	-	0.203
G	0.305	0.320	7.750	8.130
H	0.006	0.012	0.152	0.305
I	0.129	-	3.300	-
J	0.094	-	2.400	-
K	-	0.165	-	4.200
L	0.094	-	2.400	-

Part Numbering System

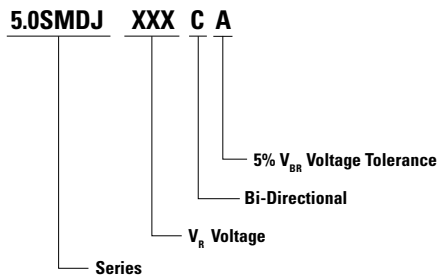

Part Marking System

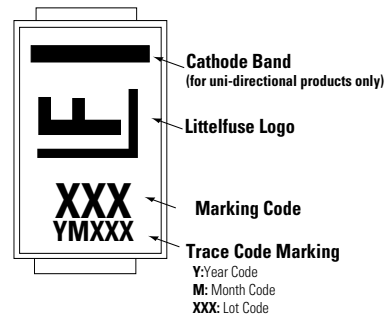

Packaging Options

Part number	Component Package	Quantity	Packaging Option	Packaging Specification
5.0SMDJxxxXX	DO-214AB	3000	Tape & Reel - 16mm tape/13" reel	EIA STD RS-481
5.0SMDJxxxXX-T7	DO-214AB	500	Tape & Reel - 16mm tape/7" reel	EIA STD RS-481

Tape and Reel Specification

